



# Modeling Free Space Optoelectronic Systems Using Ptolemy



**Steven P. Levitan**  
**Donald M. Chiarulli**

Tim P. Kurzweg  
Mark A. Rempel  
Departments of  
Electrical Engineering &  
Computer Science  
steve@ee.pitt.edu  
<http://kona.ee.pitt.edu/steve>  
University of Pittsburgh

**Philippe J. Marchand**

Chi Fan  
Fredrick B. McCormick  
Department of Electrical &  
Computer Engineering  
pmarchand@ucsd.edu  
<http://soliton.ucsd.edu>  
University of California, San Diego

👉 Funding: National Science Foundation- MIP-9421777

*chatoyant*



## Overview



*Chatoyant* is a computer aided design tool for the design of *Free Space Optoelectronic Information processing (FSOI) Systems*.

🌀 Simulation - Analysis - Synthesis - Interface

👉 Enable the modeling of FSOI systems without costly prototyping

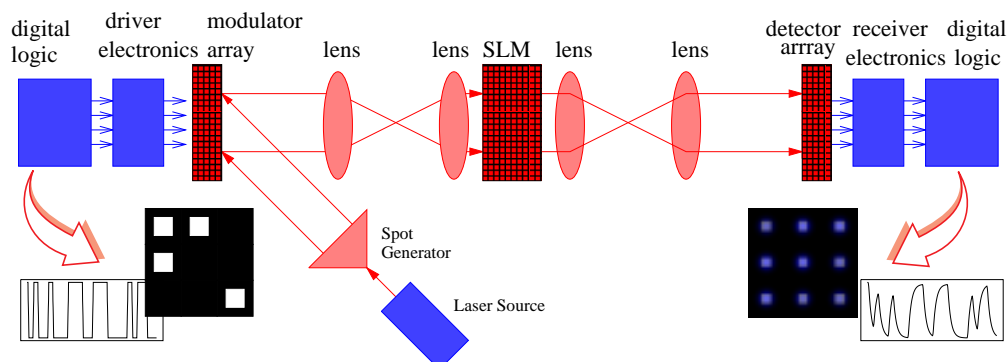

*chatoyant*



# Outline



1. Free space optoelectronic information processing systems
2. Design Issues
3. Approach/Method
4. Signal and Component Models
5. *Chatoyant*: System Modeling
6. Simulations using Ptolemy
7. Conclusions

*chatoyant*



## What's the Problem? (in O/E systems)



- ➔ O/E information processing systems are hard to design
  - ⚙ Heterogeneous systems
  - ⚙ Expensive to prototype (\$'s and time)
- ➔ Hard to simulate
  - ⚙ Systems cross technology boundaries
  - ⚙ optical - mechanical - electronic, more
- ➔ Solution:
  - ⚙ System level prototyping environment
  - ⚙ Heterogeneous tool integration
  - ⚙ 1st order - trade offs (architecture vs. technology)
  - ⚙ Interface to "point tools" for details

*chatoyant*



# “System 5” Photo



*chatoyant*



# “System 5” Physical Design

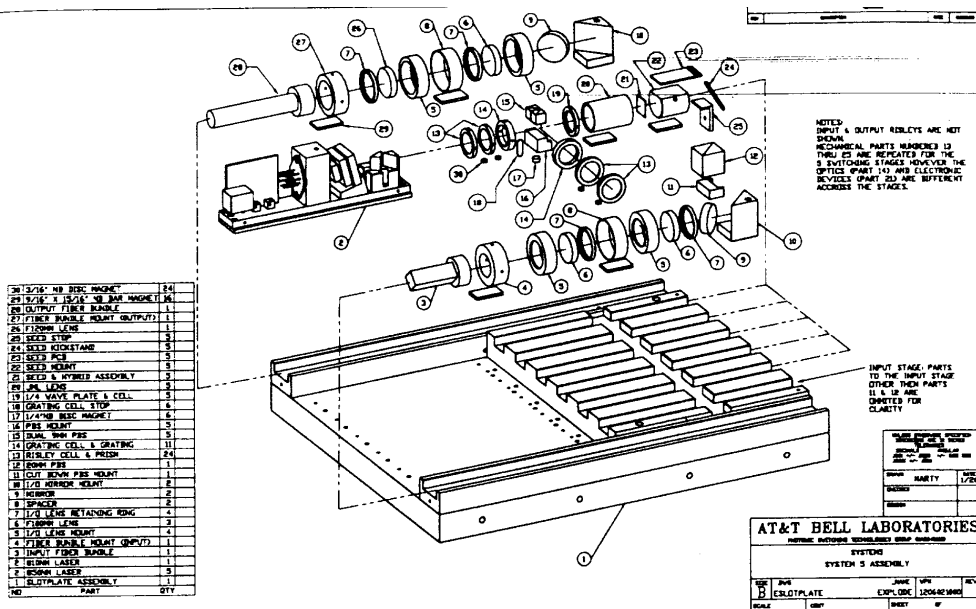

*chatoyant*



# "System 5" Optical Design

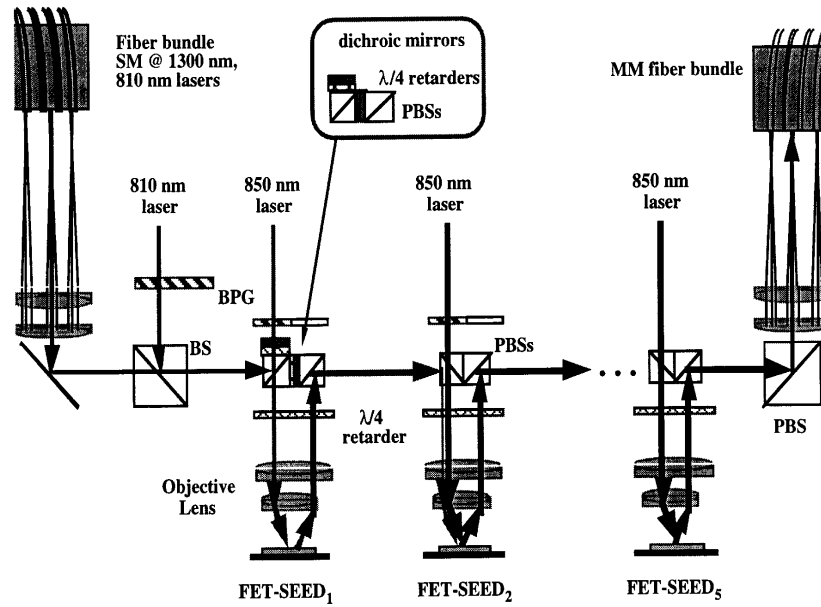

*chatoyant*



# "System 5" Functional Design

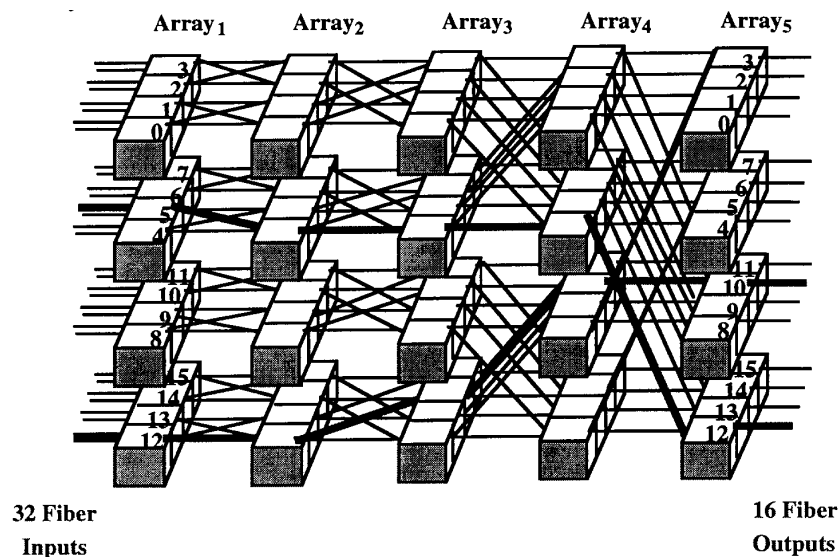

*chatoyant*



# “System 5” Electrical Design

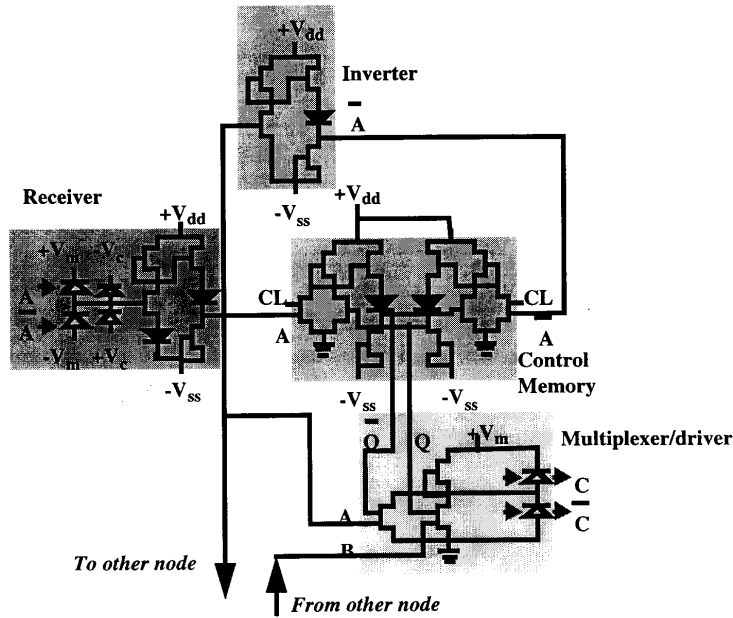

*chatoyant*



## Design Issues



Electronics	Opto-electronics	Optics	Packaging Mechanics	Thermal
Functional models	Analytic models	Image formation	Area, Volume	Power density
Logic, Timing		Gaussian beam propagation	1 <sup>st</sup> order layout	1 <sup>st</sup> order thermal expansion
Circuit	Physical models, Data fitting	Ray tracing, Diffraction analysis	Tolerancing	Finite element analysis

➡ How do these interact?

➡ How do we evaluate designs to perform architectural vs. technological (vs. cost, speed, power, etc.) trade-offs?

*chatoyant*



# Requirements for an O/E CAD System



- ➔ Support heterogeneous implementation domains
  - ⚙ Analog/digital electronics
  - ⚙ Optoelectronics
  - ⚙ Free space optics
  - ⚙ Physical 3D layout
  - ⚙ Thermal/power analysis
  
- ➔ Support multiple design levels
  - ⚙ Functional - high level
  - ⚙ Signal - mid level
  - ⚙ Physical - low level

*chatoyant*

---



## Approach



- ➔ Build a *system level* modeling tool to predict performance and analyze technology vs. architecture trade-offs
  - ⚙ Develop 1<sup>st</sup> order analytical models for optoelectronic components (drivers, transmitters, lenses, detectors, receivers, etc.)
  - ⚙ Develop and integrate numerical/physical models for optoelectronic devices (VCSELs, Modulators, etc.)
  - ⚙ Develop a hierarchical & modular software tool using Ptolemy engine
  - ⚙ Provide interfaces to existing tools (Spice, Code V, etc.)
  - ⚙ Integrate mechanical tolerancing and packaging models as the technology evolves

*chatoyant*

---



# Chatoyant



- ➔ System level modeling tool
  - ⚙ Models for signals
  - ⚙ Models for components
- ➔ Predict system performance
  - ⚙ Speed, power, weight, volume, cost, error-rate
- ➔ Understand and analyze trade-offs
  - ⚙ Perform optimizations
  - ⚙ Synthesize optics
- ➔ Interface to/from “point” tools (e.g., Code V)
- ➔ Provides a balance between accuracy and speed

chatoyant



## Chatoyant Stars in Ptolemy

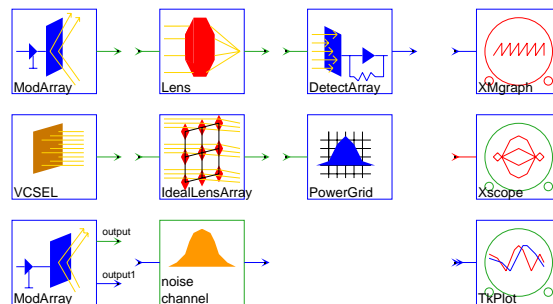

Modulators	Detectors	Lenses	Lenslets
Area	Detector Size	Focal Length	Focal Length
Spacing	Detector Spacing	Diameter	Diameter
Lambda	Distance	Distance	Distance
Spotsize	x, y offsets	x, y offsets	x, y offsets
Filename	Radius of Integration		Spacing
Gauss/Ray	R, C, A		Number

chatoyant



# Modulators\*

## $P_{abs}$ modeled with Lorentzian lineshape

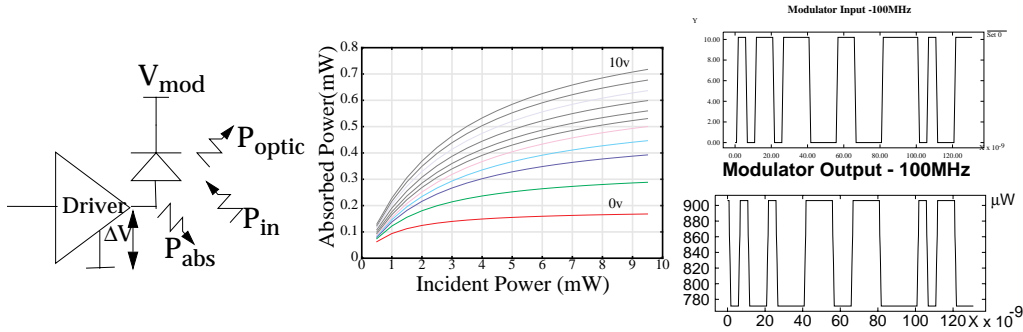

$$P_{abs}(V) = \frac{P_{in}k(V)}{1 + \frac{P_{in}}{A \cdot I_s(V)}}$$

$$P_{refl} = P_{in} - P_{abs}$$

\* C. Fan, et. al. "Digital free-space optical interconnections: a comparison of transmitter technologies", Applied Optics 34(7) pp. 3103-3115, 10 June 1995.

*chatoyant*



# Vertical Cavity Surface Emitting Lasers (VCSEL)

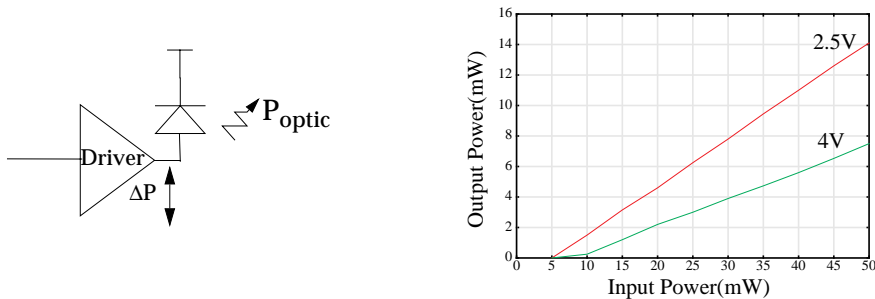

$$P_{out} = \frac{\eta_{LI}/V_t}{(1 - \eta_{LI}/V_t)} (P_{in} - I_t V_t)$$

*chatoyant*



# MQW/PIN Photo-diode Receivers with Transimpedance Amplifiers\*

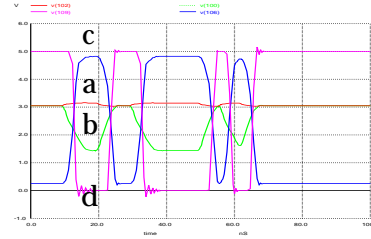
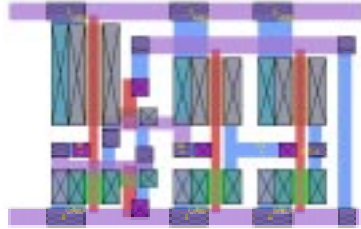
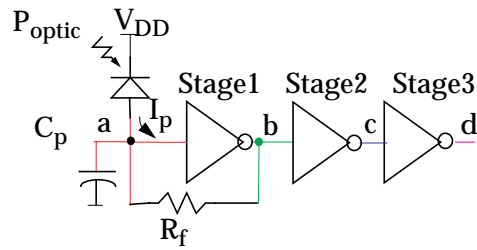

\* A.V. Krishnamoorthy et.al. IEEE Photonics Technology Letters, 7(11), Nov 1995

*chatoyant*



# Ptolemy Simulations: 4f system

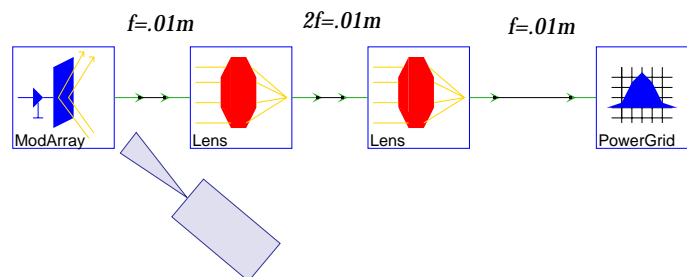
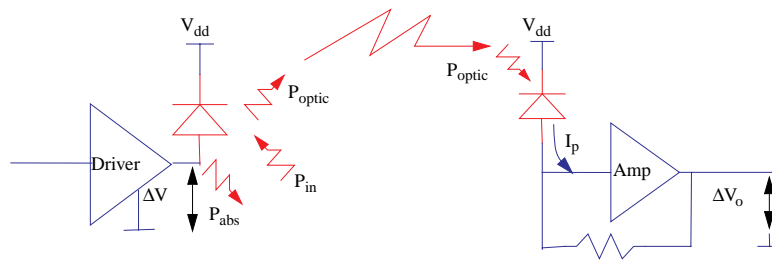

*chatoyant*



# Gaussian Beams

(good approximation for lasers)



Intensity - radial symmetry, propagation in z:

$$I(r, z) = I_0 \left[ \frac{W_0}{W(z)} \right]^2 \exp \left[ -\frac{2r^2}{W^2(z)} \right]$$

Waist size:  $W(z) = W_0 \left[ 1 + \left( \frac{z}{z_0} \right)^2 \right]^{1/2}$

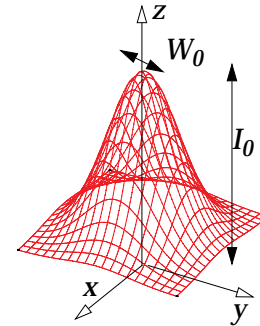

Rayleigh Range (~ depth of focus):  $z_0 = \frac{\pi W_0^2}{\lambda}$

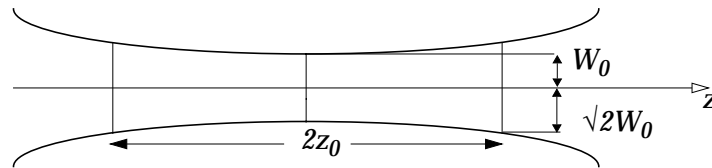

*chatoyant*



# Optical Power Simulations



(modulator volts)

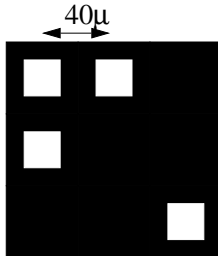

(integrate intensity)

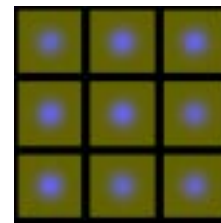
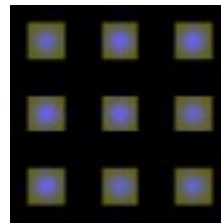
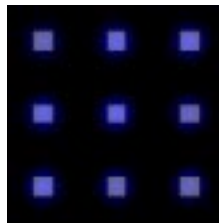

20μm spot Modulators (μW)			10μm Detectors			20μm Detectors			35mm Detectors		
771	771	906	360	422	422	703	826	826	771	905	905
771	906	906	422	422	360	826	826	703	905	905	771
906	906	771	422	360	360	826	703	703	905	771	771

*chatoyant*



# Dynamic Performance Analysis

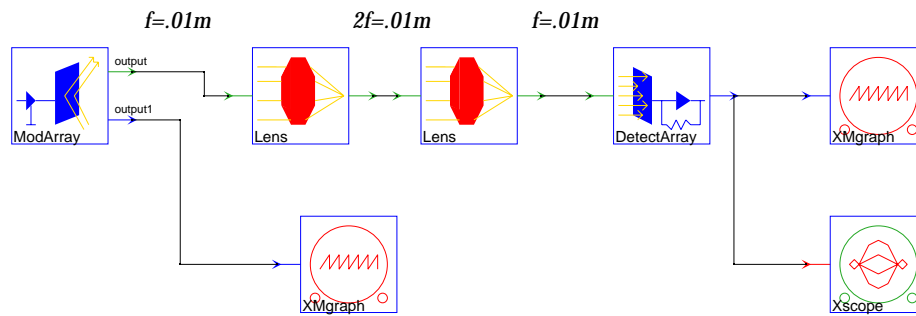

*chatoyant*



# Time Domain Analysis



➔ Method used for dynamic response of each of the modules in the system.

🌀 Example: transfer function for single stage transimpedance amplifier:

$$V_o(s) = \frac{R_f}{1 + \left(\frac{R_f C}{A}\right)s} \cdot P_{optic}(s)$$

🌀 Convert to time domain

🌀 Number of points in piece-wise linear approximation is user defined variable

*chatoyant*



# Dynamic Simulations at 100 / 300 MHz

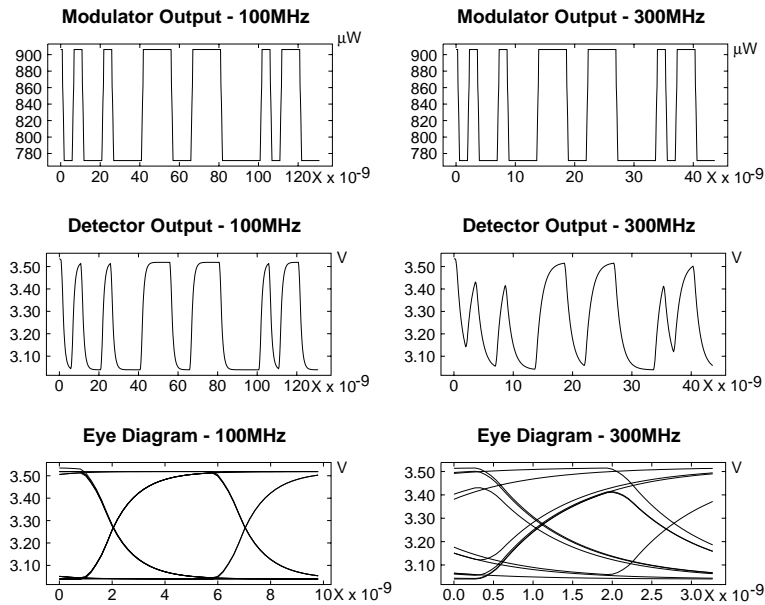

*chatoyant*



# 5μm Detectors On-center v.s. 20μm Detectors Off-center

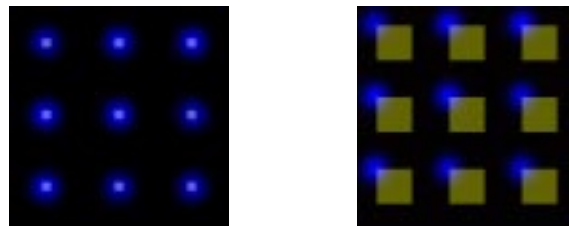

20μm Modulators			5μm Detectors			Misaligned Lens		
771	771	906	113	133	133	193	227	227
771	906	906	133	133	113	227	227	193
906	906	771	133	113	113	227	193	193

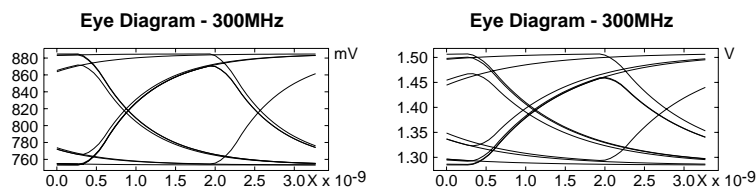

*chatoyant*



# VCSELs

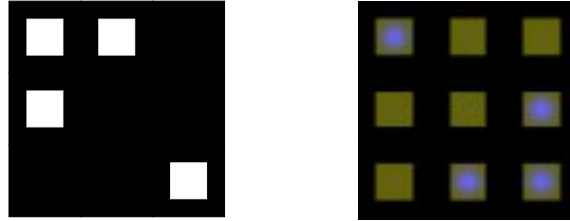

20μm Source Power (mW)			35μm Detectors(mW)			20μm Detectors(mW)		
50	50	10	14.20	1.58	1.58	12.95	1.44	1.44
50	10	10	1.58	1.58	14.20	1.44	1.44	12.95
10	10	50	1.58	14.20	14.20	1.44	12.95	12.95

VCSEL Output - 100MHz

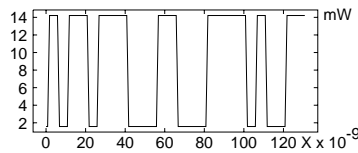

chatoyant



## Gaussian Beam Clipping by a Circular Aperture: Diffractive Effects

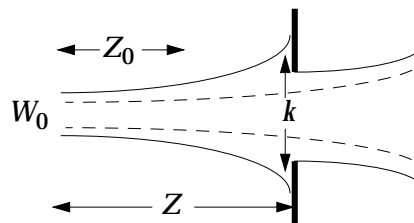

Power loss related to the size of the aperture:

$$P_{new} = P(1 - e^{-2k^2})$$

ratio of diameter of aperture to waist size at aperture:

$$k = D_{apt}/(2W_{apt})$$

chatoyant



# Effective Waist and Resultant Intensity Due to clipping

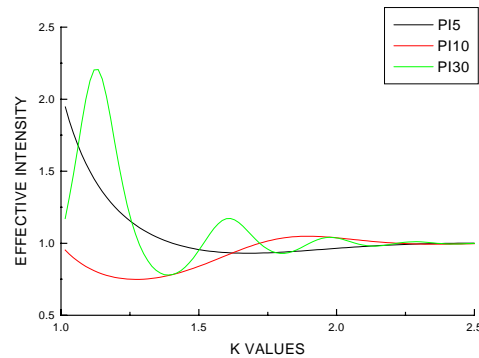
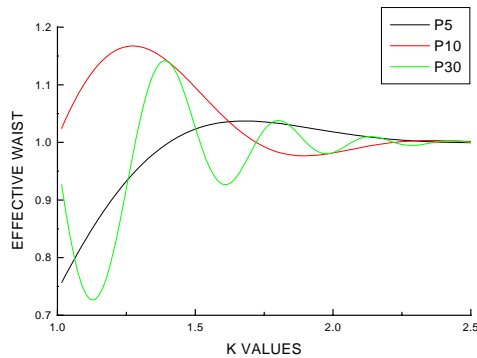

*chatoyant*

---



## Conclusions



- ➔ Optoelectronic devices and integration technologies are available now
- ➔ Tools are necessary to enable the transition from devices to systems without costly and time consuming physical prototypes.
- ➔ A system level tool provides for performance analysis, with extensions to/from “point tools”
- ➔ Interactions with industry device and system designers is critical

*chatoyant*

---