



How to Use the Horizontal Pointer Slide Tutorial

Controls -> Modern -> Numeric  -> Horizontal Pointer Slide 

Start by opening the Controls palette and opening the Modern sub-palette. Under the Modern sub-

palette, open the Numeric  palette where you should find the Horizontal Pointer Slide .

The Horizontal Pointer Slide object allows you to change or adjust an input value from the front panel. You will notice that there are increments on underneath the slider which indicate the value the Horizontal Pointer Slide outputs.

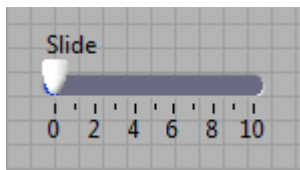

Figure 1

When first created, the bounds of the slider range are 0 to 10 as shown in Figure 1. To change the bounds of the range, simply double-click on the value of the bound you want to change and put in the desired value. You will notice that the increments auto scale in response to the change in bounds.

Note, if you double-click and change any other value under the slide that is not a bound, the value you enter will change the scaling offset if reasonable.

For instance, in Figure 2, the scale goes from 0 to 500 with a scaling offset of 250. But if we double-click and change the value of 250 to 100, the scaling offset will be changed to 100 and the result is the scale 0, 100, 200, 300, 400, and 500 as shown in Figure 3.

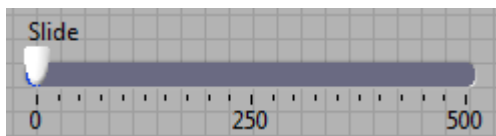

Figure 2

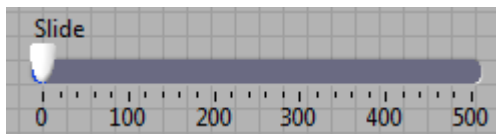

Figure 3

Generally, to make Horizontal Slide Pointers useful, we will put it in an infinite loop so that we can simulate in real time how adjusting the value supplied by the Horizontal Slide Pointer affects other values in our VI.

For example, we want to find the product of various different pairs of numbers but we also want to be able to adjust the factors during execution. To solve this problem, we simply need to put the

Horizontal Pointer Slide into an infinite loop which terminates upon an explicit “stop” signal as shown in Figure 4.

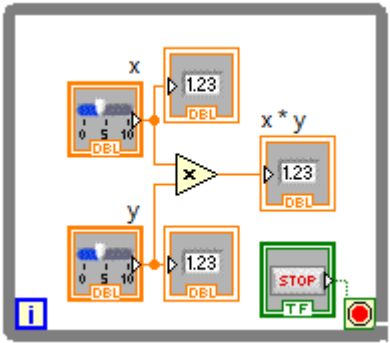

Figure 4

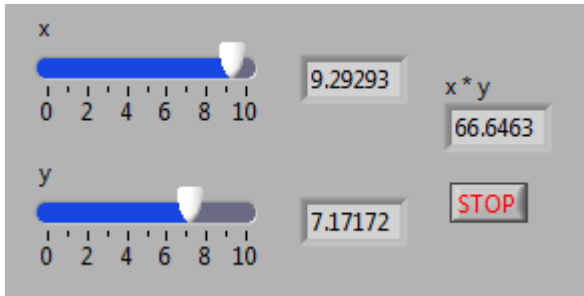

Figure 5

Figure 5 shows the execution of the VI generated by Figure 4.