

Embedded System Design

Stephen A. Edwards

Columbia University

Spring 2011

Spot the Computer

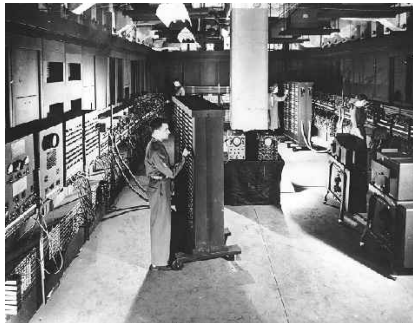

Embedded Systems: Ubiquitous Computers



iPhone



Laser Keyboard



Nikon D300



Video Watch



GPS



Playstation 3



PC Keyboard



SD Card

Is Your Current Embedded Project...

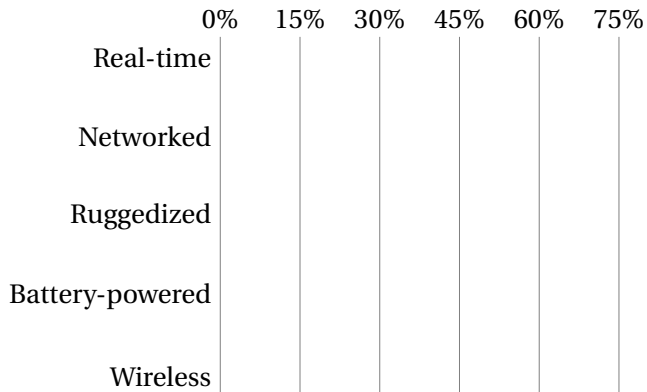

Source: 2009 Embedded Market Study

Is Your Current Embedded Project...

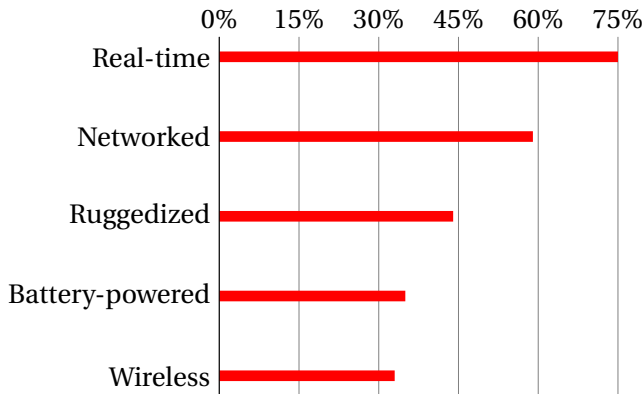

Source: 2009 Embedded Market Study

Digital Camera Block Diagram

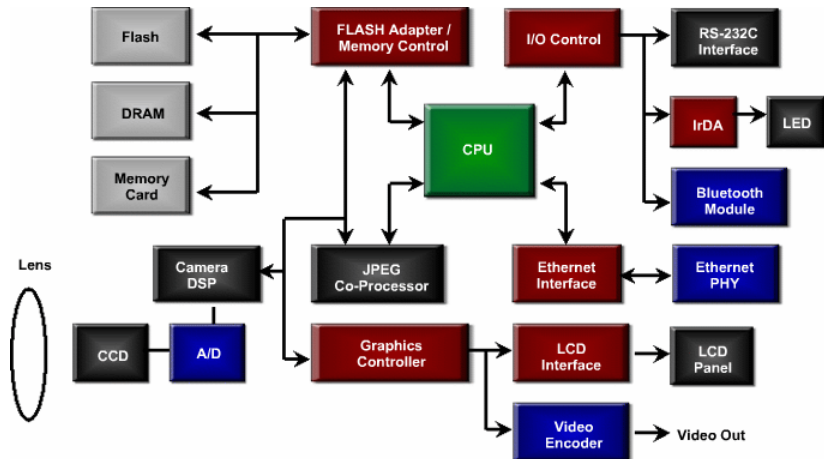

Design An Optimal Device that Meets Constraints On



Price



Functionality



Performance



Size



Power



Time-to-market



Maintainability



Safety

Embedded System Technologies

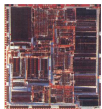

Integrated Circuits



Processing elements



Design tools

IC Technology



1947: First transistor (Shockley, Bell Labs)



1958: First integrated circuit (Kilby, TI)



1971: First microprocessor (4004: Intel)



Today: eight wire layers, 45 nm features

Moore's Law: Transistors per chip

“The complexity for minimum component costs has increased at a rate of roughly a factor of two per year. Certainly over the short term this rate can be expected to continue, if not to increase.”

— Gordon Moore, 1965

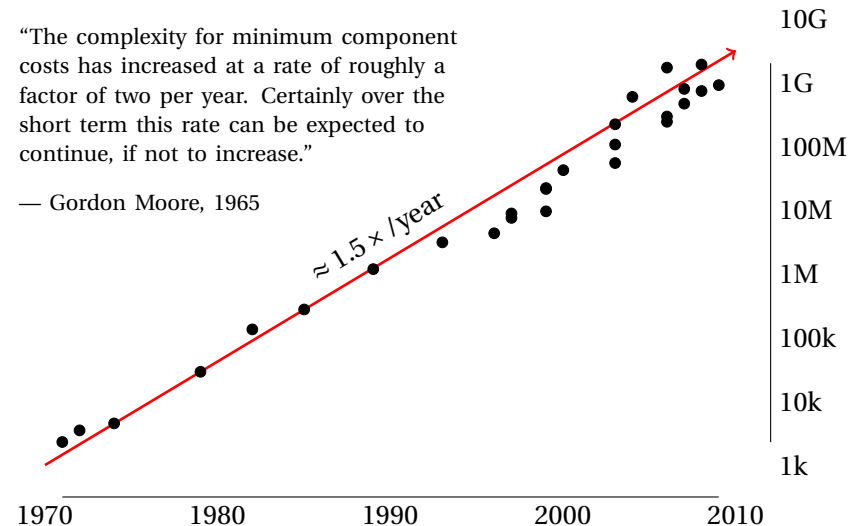

Source: Intel/Wikipedia

\$1000 Buys You This Many CPS

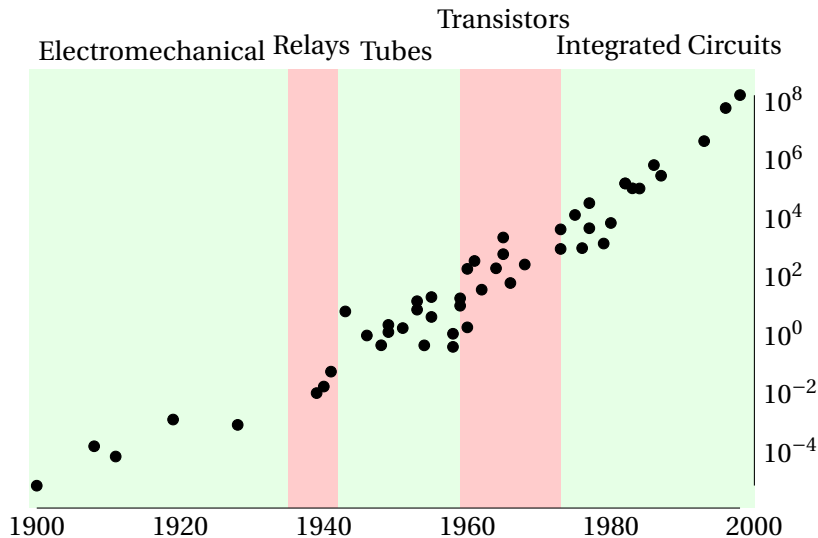

Source: Ray Kurzweil, *The Age of Spiritual Machines*

1918 Sears Roebuck Catalog

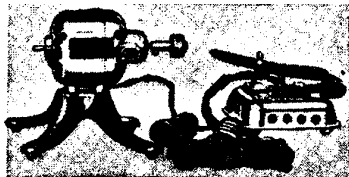

Home Motor.

This motor, as shown above, will operate a sewing machine. Easily attached; makes sewing a pleasure. The many attachments shown on this page may be operated by this motor and help to lighten the burden of the home. Operates on usual city current of 105 to 115 volts. Shipping weight, about 5 pounds.

No. 57P7564 Price, complete, as shown..... **\$8.75**

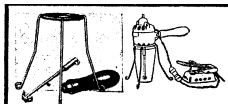
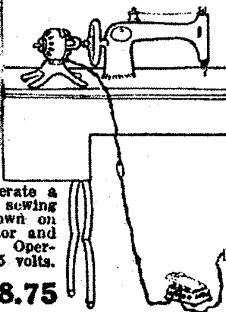

Beater Attachment.

Whips cream and beats eggs, and many other uses will be found for these attachments when used in connection with the Home Motor. Parts include the stand, handle and the beater. Shipping weight, about 14 ounces.

No. 57P7585 Price..... **\$1.30**



Churn and Mixer Attachment.

Used in connection with the Home Motor, makes a small churn and mixer for which you will find many uses. The attachments include the base, supports, mixer, handle and special cover for jar. Shipping weight, about 1 1/2 pounds.

No. 57P7582 Price..... **\$1.30**

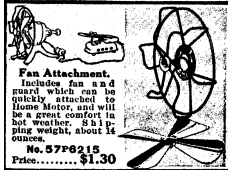

Fan Attachment.

Includes fan and guard which can be quickly attached to Home Motor, and will be a great comfort in hot weather. Shipping weight, about 14 ounces.

No. 57P8215 Price..... **\$1.30**

About \$100 in today's dollars.

From Donald Norman, *The Invisible Computer*, 1998.

What Percentage of Time Do You Spend...

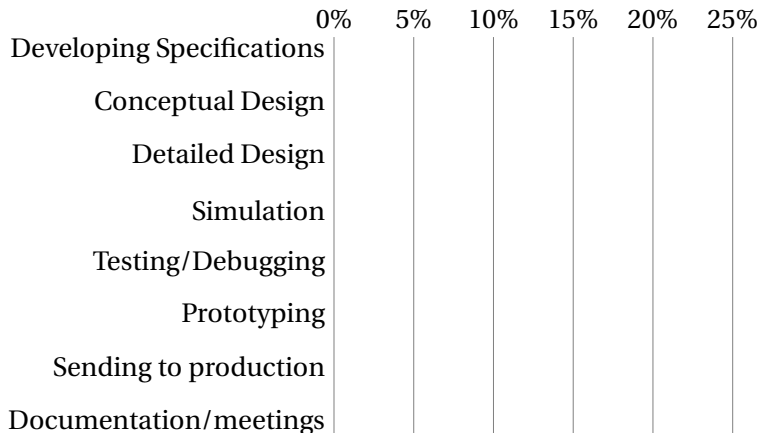

Source: 2009 Embedded Market Study

What Percentage of Time Do You Spend...

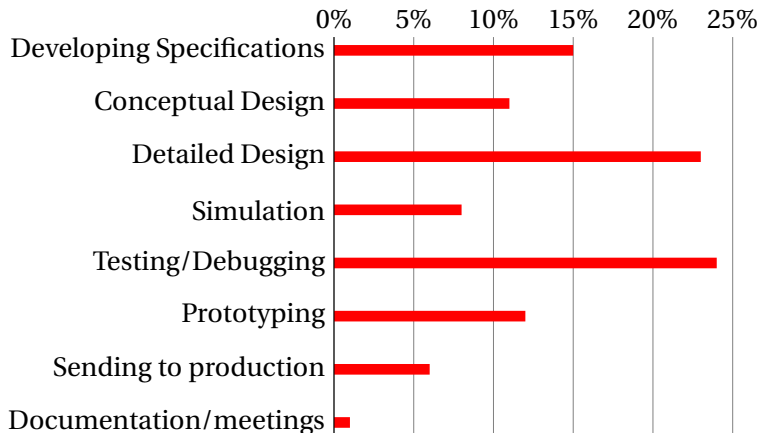

Source: 2009 Embedded Market Study

If You Could Improve One Thing...

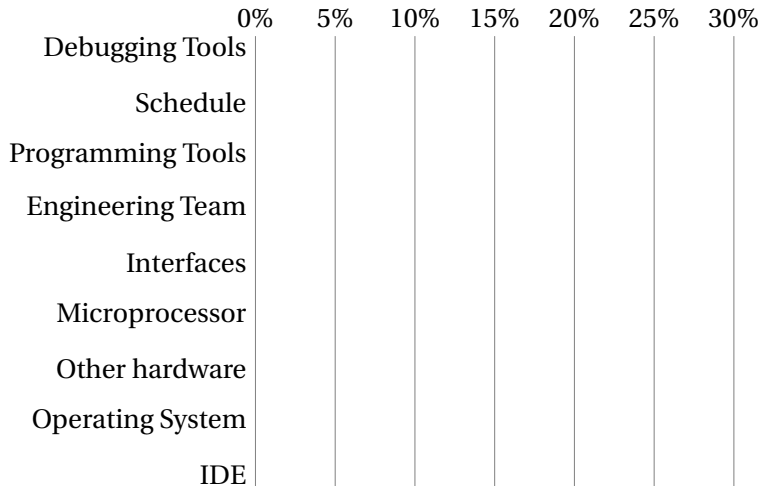

Source: 2009 Embedded Market Study

If You Could Improve One Thing...

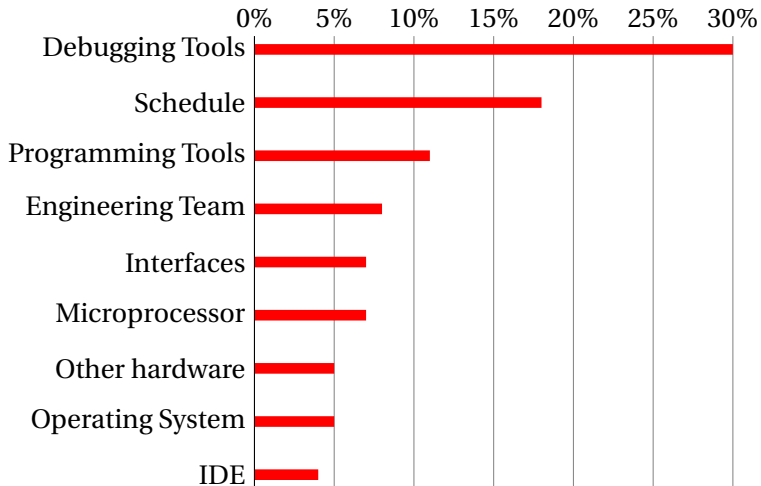

Source: 2009 Embedded Market Study

If Your System Has More Than One Processor, Does It Use...

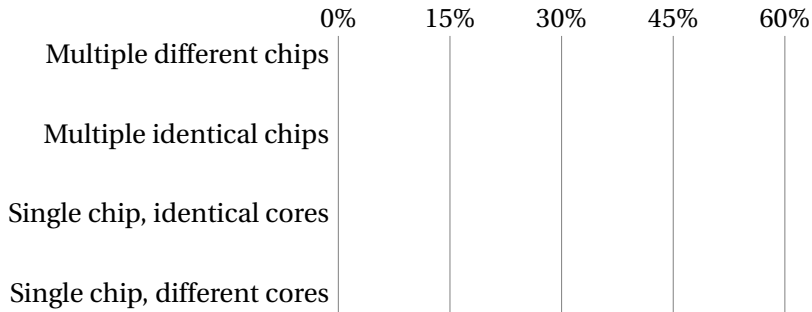

Source: 2009 Embedded Market Study

If Your System Has More Than One Processor, Does It Use...

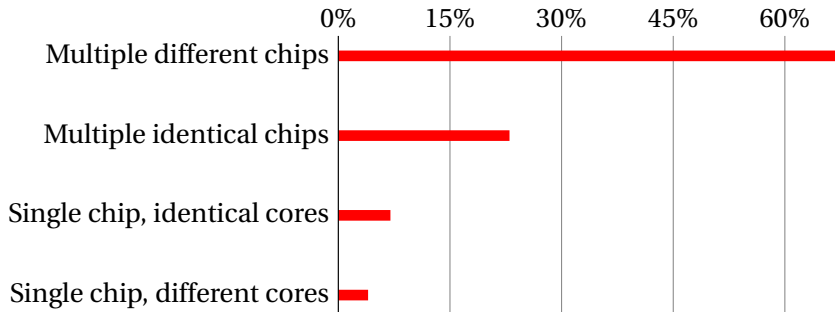

Source: 2009 Embedded Market Study

Does Your Current Project Contain FPGAs?

Does Your Current Project Contain FPGAs?

45% Yes

55% No

Source: 2009 Embedded Market Study

Why Won't Your *Next* Project Use FPGAs?

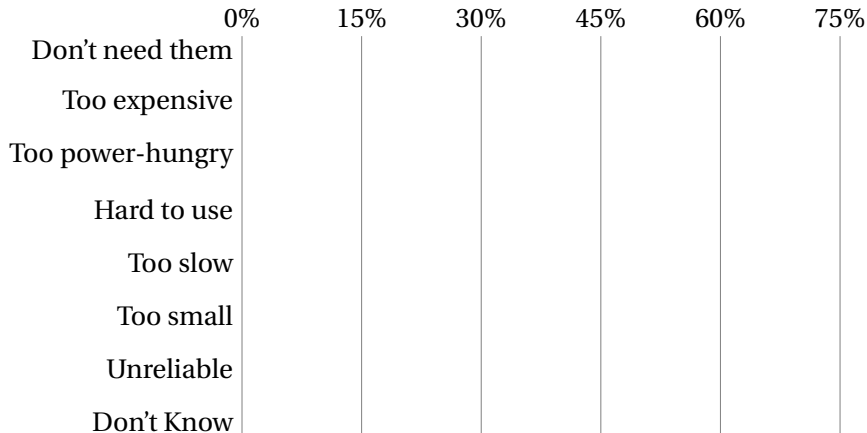

Source: 2009 Embedded Market Study

Why Won't Your *Next* Project Use FPGAs?

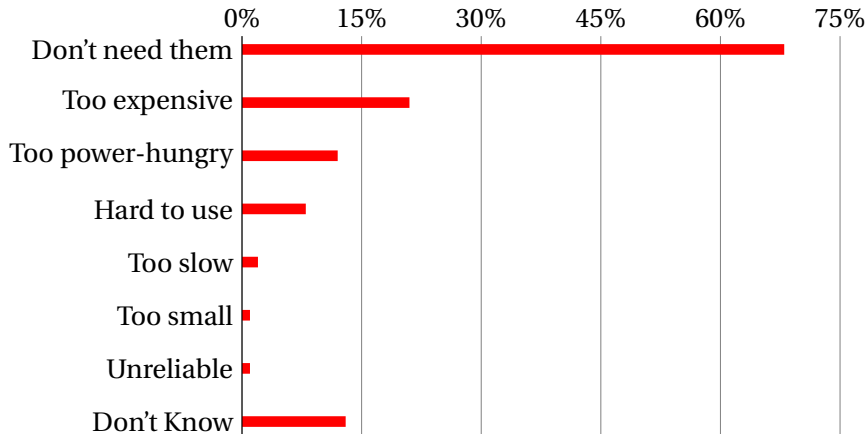

Source: 2009 Embedded Market Study

Your Nemesis: The Altera DE2

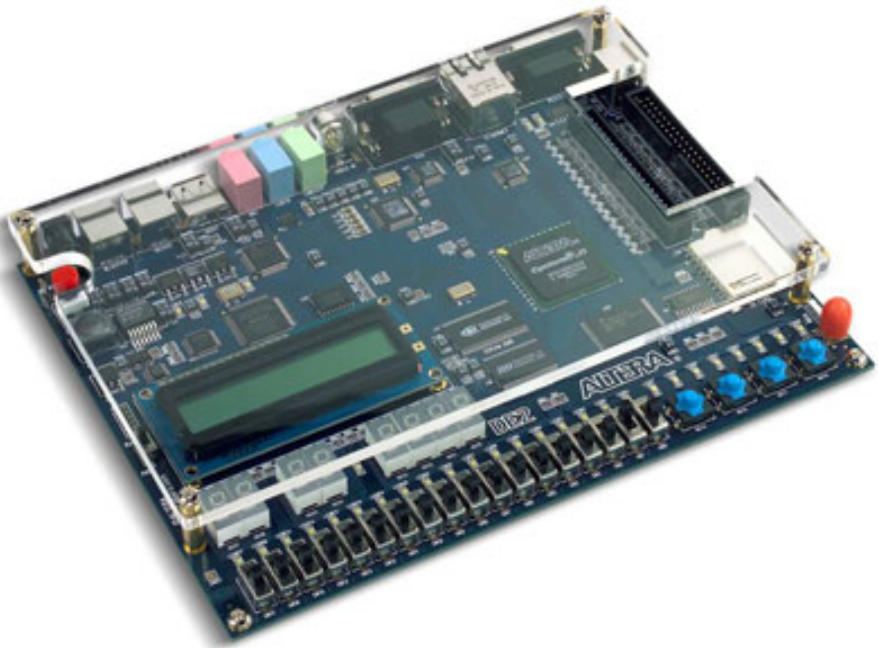

DE2 Peripherals

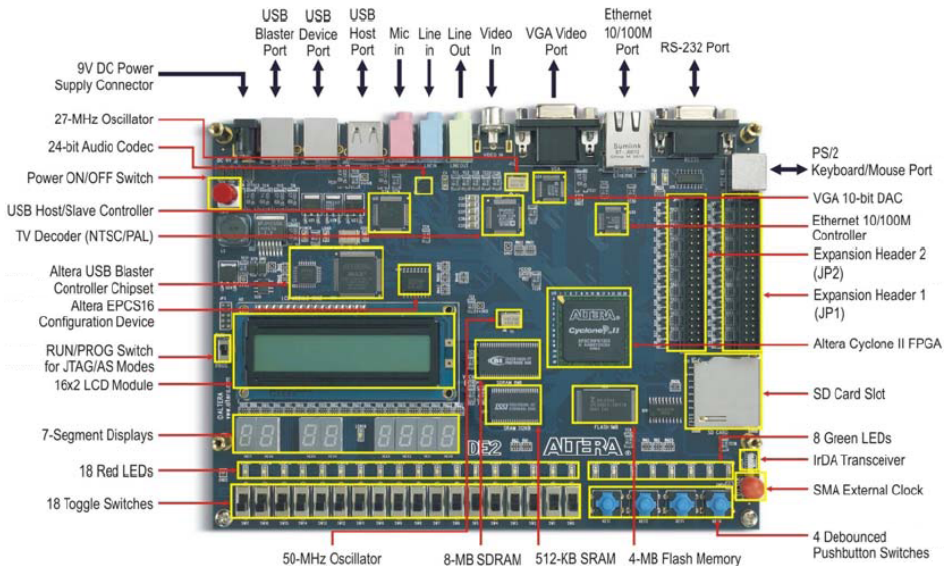

Class Structure

Three Introductory Labs: 2 weeks each

1. Access, modify, and display memory in VHDL
2. An Ethernet chat client (software only)
3. Either
 - ▶ an FM audio synthesizer; or
 - ▶ a video bouncing ball.

The project: **Design-your-own**

Custom Project Ideas

Broadly: C + VHDL + peripheral(s)



Video game (e.g., Pac-Man)



Video effects processor



Digital photo frame



Very fancy digital clock

More Ideas



Digital tone control



Real-time audio spectrum analyzer



Internet radio



Speech Synthesizer

Projects from 2004



MIDI synthesizer

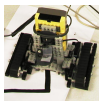

Line-following robot with video vision



SAE student vehicle telemetry system



Stereo video vision system



Internet video camera



Pac-man-like video game

Projects from 2005



Scrabble Timer

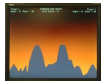

Scorched Earth



SAE Auto Shifter



Internet Radio
Broadcaster



3D Maze Game



VoIP Telephone



JPEG decoder



Rally-X video game

Projects from 2006



Video-guided Lego Robot



360° camera de-warper



Videogame with accelerated line-drawing



Voice recorder



JPEG decoder

Projects from 2007



Pac-Edwards



Button Hero Videogame



Digital Picture Frame: SD card with JPEG to VGA



Networked game of Clue



Conway's Game of Life (60 gps)

Projects from 2008



Real-time ray tracer



Video-camera-controlled pool game



Real-time video decryption



WiiMote-controlled maze game

Projects from 2009



Lightsaber video overlay



Networked Video Phone



Sound-controlled videogame



Visual object tracker

The Three Main Challenges of Embedded Systems

- ▶ Coping with Real-world Sensor Data
- ▶ Algorithm Design
- ▶ Implementation Details

What Does this Circuit Do When You Press the Switch?

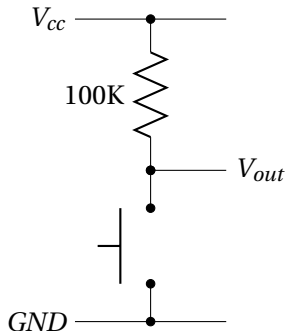

What Does this Circuit Do When You Press the Switch?

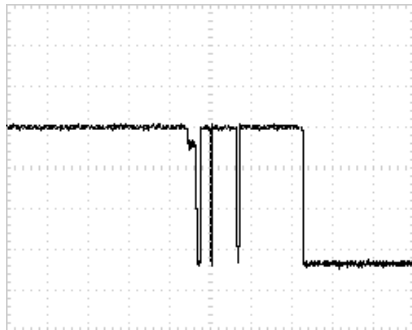
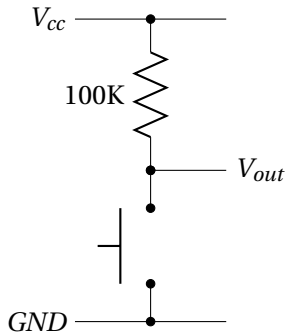

Inside a Pushbutton Switch

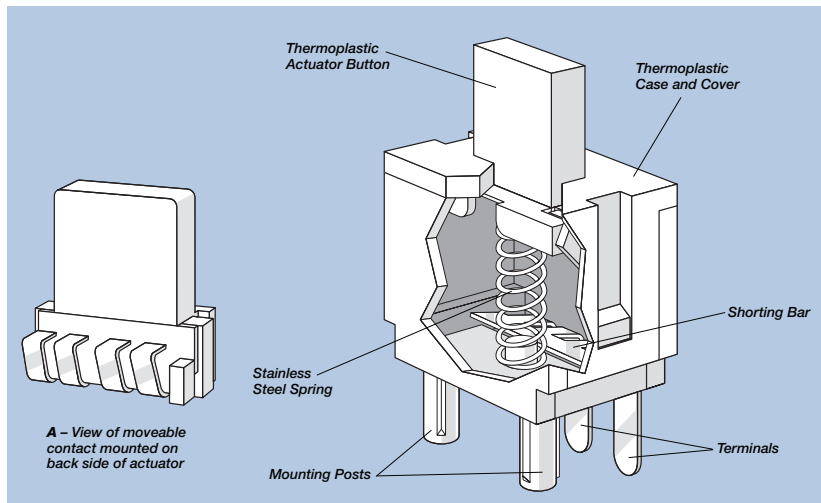

Source: Cheery CS series data sheet

Raw Data from a CCD (zoomed in)

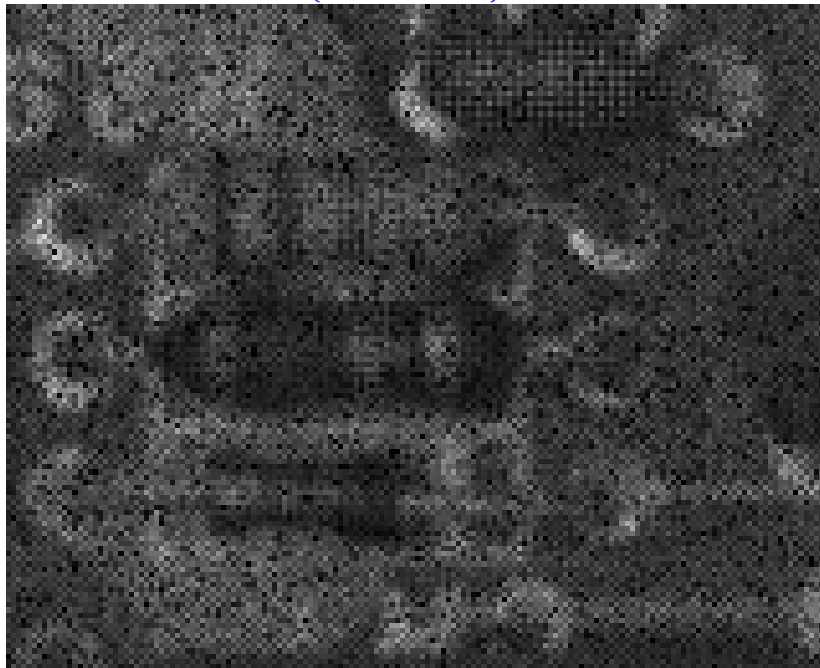

Corrected Image (zoomed in)

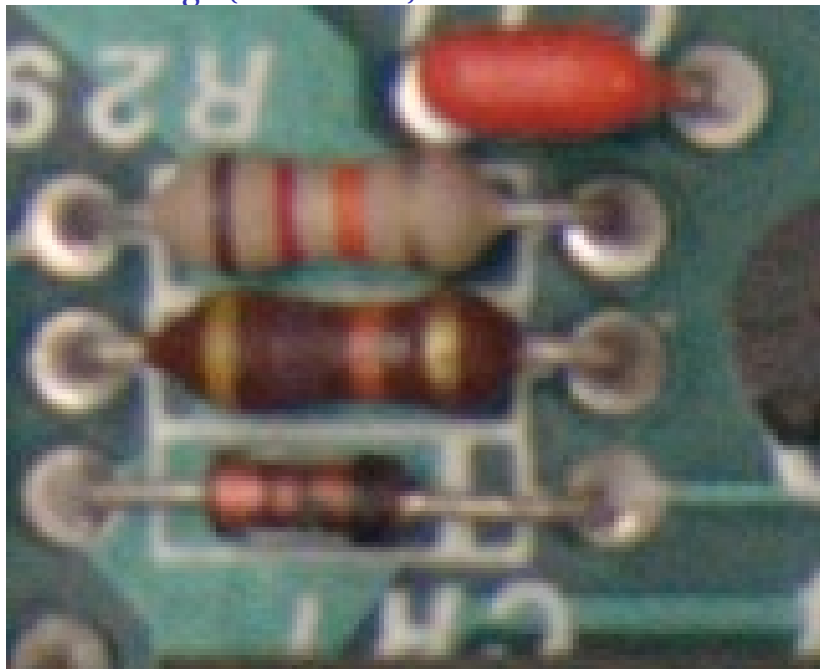

Correcting Data from CCDs

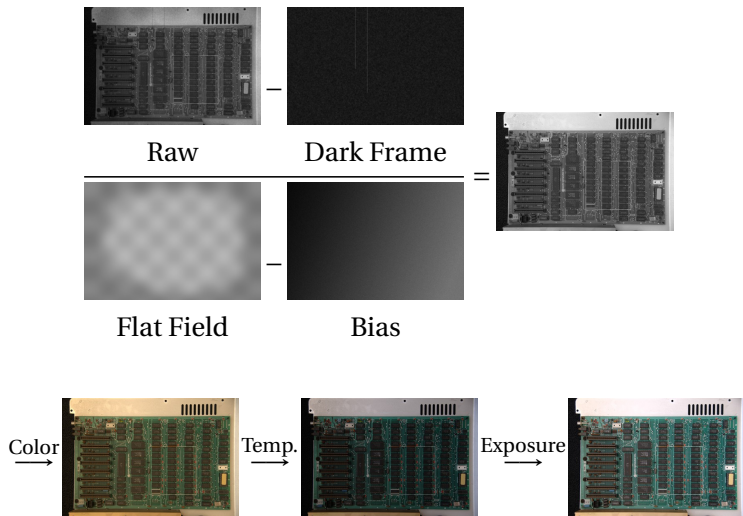

Correcting Data from CCDs

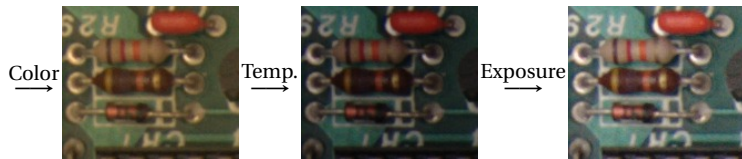
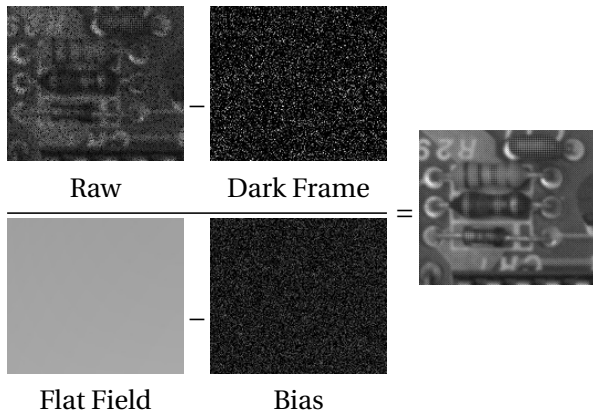

Where Does This Noise Come From?

Digital camera sensors are remarkably sensitive. My high-end Nikon D300 has a 23.6 mm \times 15.8 mm 12.3 megapixel CMOS sensor whose pixels are 5.5 μm on a side. When each pixel is sampled with the 12-bit A/D converter, the sensor efficiency is



ISO:	LO	200	400	800	1600	3200
G	7.1	5.5	2.7	1.3	0.65	0.33
B	5.8	4.6	2.3	1.1	0.55	0.27
R	4.7	4.5	2.2	1.1	0.54	0.26

The units: *electrons per ADU* (digital unit).

Emil Martinec, *A comparison of the Nikon D300 and Canon 40D sensors*, 2007.

Development Plan

1. Obtain some representative raw sensor data
2. Develop an algorithmic prototype using your favorite language (e.g., Java, C, Matlab)
3. Plan how to implement it
4. Implement while constantly testing