

Networking, USB, and Threads

CSEE W4840

Prof. Stephen A. Edwards

Columbia University

Spring 2023

Ethernet and the Internet

Sockets

USB: The Universal Serial Bus

libusb 1.0

POSIX Threads (pthreads)

Ethernet and the Internet

Ethernet

Started in about 1976 at Xerox PARC

IEEE Standard 802.3

Carrier-sense multiple access/carrier detect protocol:

1. Listen to the cable
2. If nobody's there, start talking
3. If someone interrupts, stop, and retry after a random time

10Base-5 "Thicknet"

Shared coax bus with "vampire tap" transceivers 802.3 std. suggests yellow

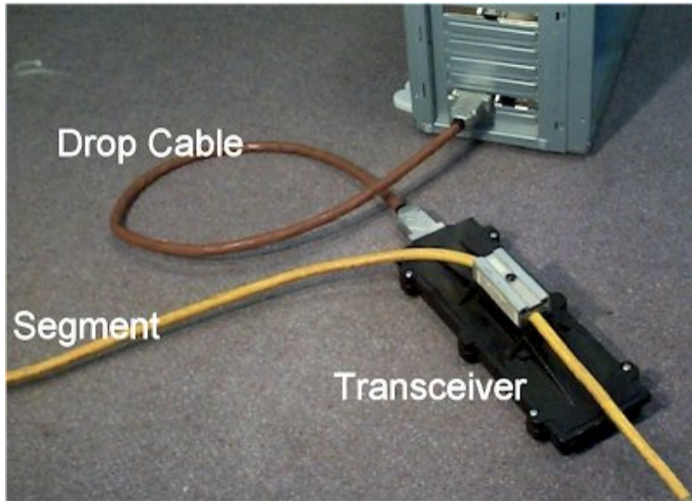

10Base-2 "Thinnet"

50-Ohm coax segments with BNC "T" connectors Coax invariably black

From Computer Desktop Encyclopedia
© 1998 The Computer Language Co. Inc.

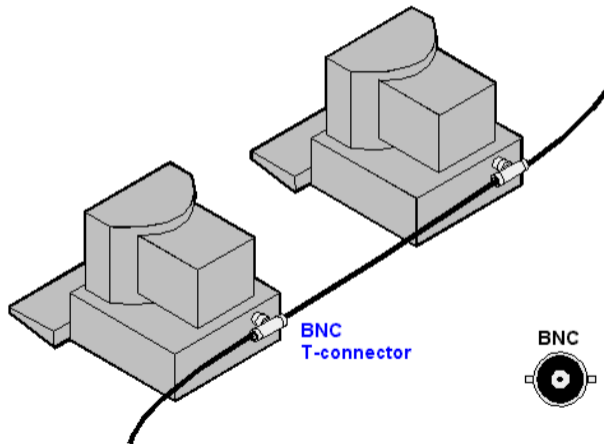

10Base-T and 100Base-T

Put the shared medium in a hub: star topology

Everybody uses it now

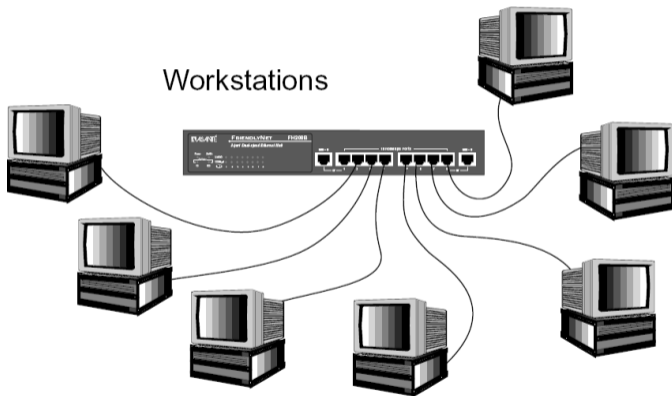

Star topology



Choice of colors

From <http://www.asante.com/downloads/legacy/fh200bugra.pdf> and http://www.connectworld.net/cables_u/patch-cable-manufacturer.html

100Base-TX wiring (CAT 5)

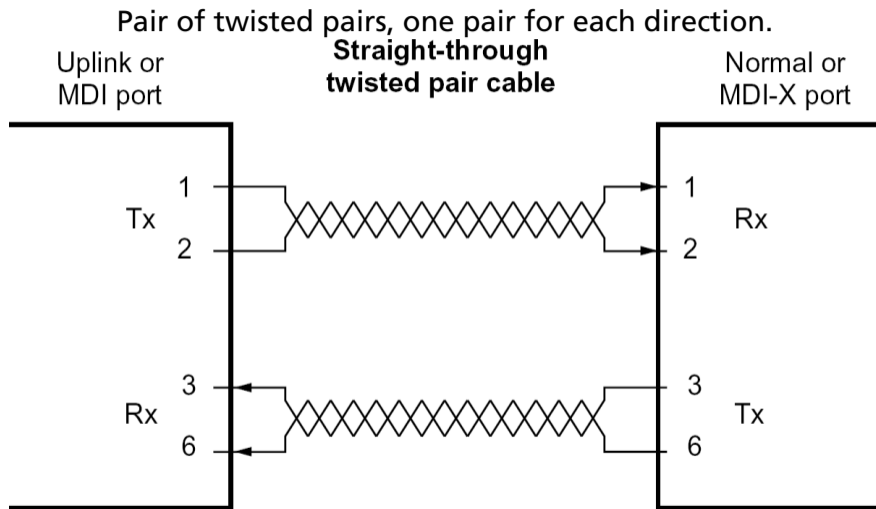

Hub-to-computer cable is straight-through.

Computer-to-computer cable is a "crossover;" most hardware can now adapt

An Ethernet Frame

7 bytes	1	6	6	2	46–1500	4
Preamble	SOF	Dest.	Src.	Type	Payload	Checksum

SOF Start of Frame

Dest. Destination address

Src. Source address

Type Type of packet or length of data field
0x0800 for IP, 0x0806 for ARP, etc.

Bytes sent LSB first

Minimum packet length: 64 (6 + 6 + 2 + 46 + 4)

Lengths > 1500 indicate packet type

Ethernet (MAC) addresses

48 bits \approx 281 trillion (world population: 7.9 billion)

Bits 48–24 Vendor code (OUI)

Bit 41 0=ordinary, 1=group (broadcast) address

Bits 23–0 Serial number

On one of my machines:

```
$ ifconfig eth0  
eth0 Ethernet HWaddr 00:18:f3:ef:2b:36
```

OUI (Organizationally Unique Identifier):

00:18:f3 is ASUS (the machine's motherboard manufacturer)

Address FF:FF:FF:FF:FF:FF is broadcast

An Ethernet Packet

00d006269c00	Destination MAC address (router)
00087423ccab	Source MAC address (desktop)
0800	Type = IP packet
45	IPv4, 5 word (20-byte) header
00	Normal service
0028	Total length = 40 bytes
c31c	Identification (unique)
4000	"Don't Fragment"
40	64 hops to live
06	TCP protocol
3ff1	Header checksum (one's complement)
803b1372	Source IP 128.59.19.114 (desktop)
40ec6329	Destination IP 64.236.99.41

deac 0050 bf49 9ba6 a1a4 8bed 5010 ffff 1093 0000 (payload)

IP Addresses

32 bits \approx 4 billion (world population: 7.9 billion)

First n bits indicate network ($n = 8, 16, 24$)

For example, columbia.edu
owns 128.59.0.0 – 128.59.255.255

Magical addresses:

127.0.0.1	“Me”
192.168.x.x	Never assigned worldwide
10.x.x.x	Never assigned worldwide
255.255.255.255	Broadcast

Sockets

Sockets

```
// Create an Internet socket (SOCK_STREAM = TCP)
int sockfd = socket(AF_INET, SOCK_STREAM, 0);

#define IPADDR(a,b,c,d) (htonl(((a)<<24)|((b)<<16)|((c)<<8)|(d)))

#define SERVER_HOST IPADDR(192,168,1,1)
#define SERVER_PORT htons(42000)           // host to network byte order short

struct sockaddr_in serv_addr = { AF_INET, SERVER_PORT, { SERVER_HOST } };

// Connect to the server
connect(sockfd, (struct sockaddr *) &serv_addr, sizeof(serv_addr));

// Write to the socket
write(sockfd, "Hello_World!\n", 13);

// Read from the socket: block until data arrives
#define BUFFER_SIZE 128
char recvBuf[BUFFER_SIZE];
read(sockfd, &recvBuf, BUFFER_SIZE - 1));
```

USB: The Universal Serial Bus

USB: Universal Serial Bus

1.5 Mbps, 12 Mbps, 480 Mbps (USB 2.0), 5 Gbps (USB 3.0; two additional pairs)

Point-to-point, differential, twisted pair

3–5m maximum cable length

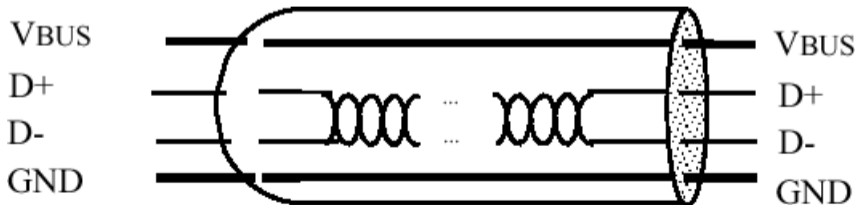

Series "A" Connectors

- ◆ Series "A" plugs are always oriented **upstream** towards the *Host System*

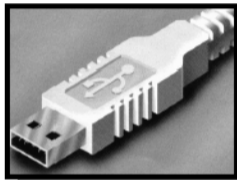

"A" Plugs
(From the
USB Device)

"A" Receptacles
(Downstream Output
from the USB Host or
Hub)



Series "B" Connectors

- ◆ Series "B" plugs are always oriented **downstream** towards the *USB Device*

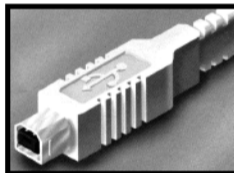

"B" Plugs
(From the
Host System)

"B" Receptacles
(Upstream Input to the
USB Device or Hub)

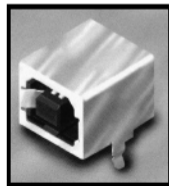

USB signaling

NRZI: 0 = toggle, 1 = no change

Bit stuffing: 0 automatically inserted after six consecutive 1s

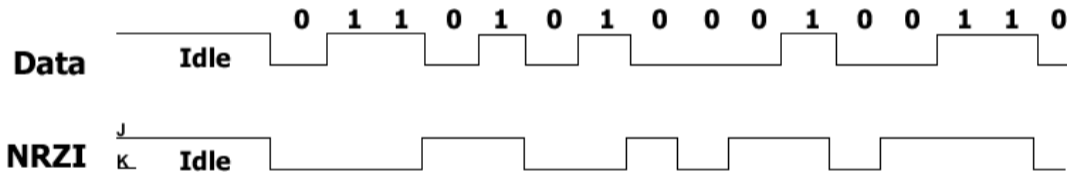

Each packet prefixed by a SYNC field: 0 0 0 1 1

Low- vs. full-speed devices identified by different pull-ups on D+/D- lines

USB Packets

Always start with SYNC

4-bit type; 4-bit type complemented

2 bits distinguish Token, Data, Handshake, and Special; two more bits select sub-types

Data, depending on packet type

Data checked using a CRC

Addresses (1-128) assigned by bus master, each with 16 possible endpoints

USB Protocol

Polled bus (USB 1.0, 2.0): host initiates all transfers. USB 3.0 is full-duplex

Most transactions involve three packets:

- ▶ “Token” packet from host requesting data
- ▶ Data packet from target
- ▶ Acknowledge from host

Supports both streams of bytes and structured messages (e.g., control changes).

USB Data Flow Types

- ▶ **Control**
For configuration, etc.
- ▶ **Bulk Data**
Arbitrary data stream: bursty
- ▶ **Interrupt Data**
Timely, reliable delivery of data. Usually events.
- ▶ **Isochronous Data**
For streaming real-time transfer: prenegotiated bandwidth and latency

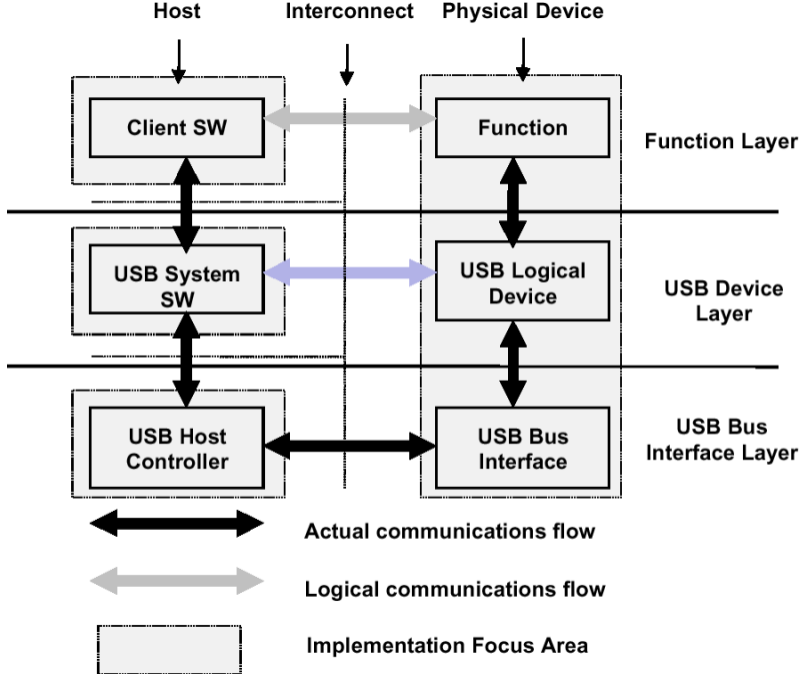

USB Bus Topology

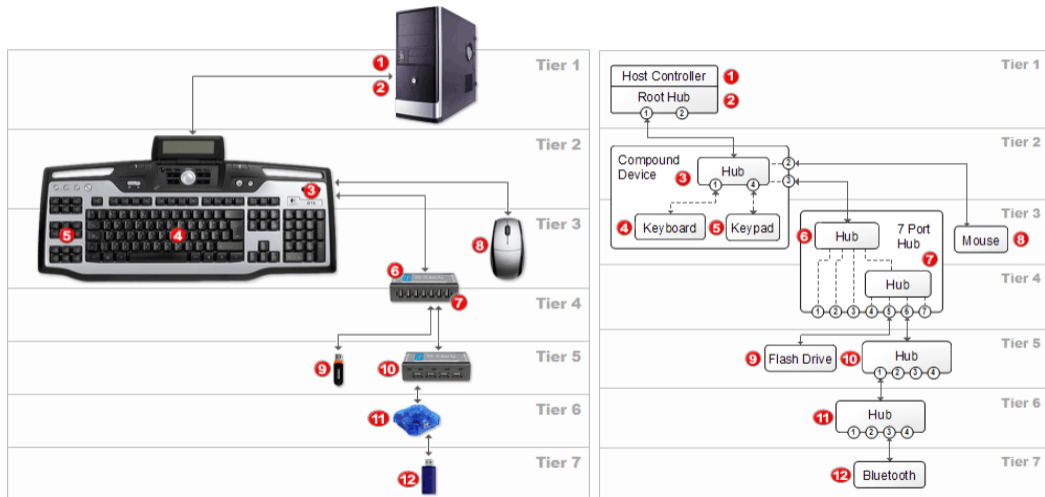

Source: <http://www.usblyzer.com/usb-topology.htm>

lsusb output

Front: USB keyboard

Back: IR receiver

Back: Monitor hub w/
webcam
microphone

Back: 7-port hub w/
SD card reader
Bluetooth dongle
SoCKit board (USB Blaster)
SoCKit board (Serial)

```
Bus 002 Device 001: ID 1d6b:0001 Linux Foundation 1.1 root hub
Bus 002 Device 002: ID 0471:0815 Philips (or NXP) eHome Infrared Receiver
Bus 002 Device 006: ID 04d9:1203 Holtek Semiconductor, Inc. Keyboard
Bus 001 Device 001: ID 1d6b:0002 Linux Foundation 2.0 root hub
Bus 001 Device 002: ID 0409:005a NEC Corp. HighSpeed Hub
Bus 001 Device 039: ID 03f0:b116 Hewlett-Packard Webcam
Bus 001 Device 005: ID 0409:005a NEC Corp. HighSpeed Hub
Bus 001 Device 041: ID 03f0:3724 Hewlett-Packard Webcam
Bus 001 Device 004: ID 04cc:1521 ST-Ericsson USB 2.0 Hub
Bus 001 Device 006: ID 0bda:0119 Realtek Semiconductor Corp. Storage Device (SD card reader)
Bus 001 Device 007: ID 0a5c:2101 Broadcom Corp. BCM2045 Bluetooth
Bus 001 Device 042: ID 09fb:6810 Altera
Bus 001 Device 043: ID 0403:6001 Future Technology Devices International, Ltd FT232 USB-Serial (UART) IC
```

lsusb -t output

Front: USB keyboard

Back: IR receiver

Back: Monitor hub w/

webcam

microphone

Back: 7-port hub w/

SD card reader

Bluetooth dongle

SoCKit board (USB Blaster)

SoCKit board (Serial)

```
/: Bus 02.Port 1: Dev 1, Class=root_hub, Driver=ohci-pci/10p, 12M
  |__ Port 3: Dev 2, If 0, Class=Vendor Specific Class, Driver=mceusb, 12M
  |__ Port 5: Dev 6, If 0, Class=Human Interface Device, Driver=usbhid, 1.5M
  |__ Port 5: Dev 6, If 1, Class=Human Interface Device, Driver=usbhid, 1.5M
/: Bus 01.Port 1: Dev 1, Class=root_hub, Driver=ehci-pci/10p, 480M
  |__ Port 2: Dev 2, If 0, Class=Hub, Driver=hub/4p, 480M
    |__ Port 3: Dev 39, If 0, Class=Video, Driver=uvcvideo, 480M
    |__ Port 3: Dev 39, If 1, Class=Video, Driver=uvcvideo, 480M
    |__ Port 3: Dev 39, If 2, Class=Audio, Driver=snd-usb-audio, 480M
    |__ Port 3: Dev 39, If 3, Class=Audio, Driver=snd-usb-audio, 480M
    |__ Port 4: Dev 5, If 0, Class=Hub, Driver=hub/2p, 480M
      |__ Port 2: Dev 41, If 0, Class=Mass Storage, Driver=usb-storage, 480M
  |__ Port 4: Dev 4, If 0, Class=Hub, Driver=hub/7p, 480M
    |__ Port 2: Dev 6, If 0, Class=Mass Storage, Driver=usb-storage, 480M
    |__ Port 3: Dev 7, If 0, Class=Wireless, Driver=btusb, 12M
    |__ Port 3: Dev 7, If 1, Class=Wireless, Driver=btusb, 12M
    |__ Port 3: Dev 7, If 2, Class=Vendor Specific Class, Driver=, 12M
    |__ Port 3: Dev 7, If 3, Class=Application Specific Interface, Driver=, 12M
    |__ Port 5: Dev 42, If 0, Class=Vendor Specific Class, Driver=, 480M
    |__ Port 6: Dev 43, If 0, Class=Vendor Specific Class, Driver=ftdi_sio, 12M
```

Devices, Configurations, Interfaces, and Endpoints

Devices	Keyboards, Mice: physical object
Configurations	usually one
Interfaces	"logical device": usually one; my webcam has 4
Endpoints	one per input/output stream

USB Addresses and Endpoints

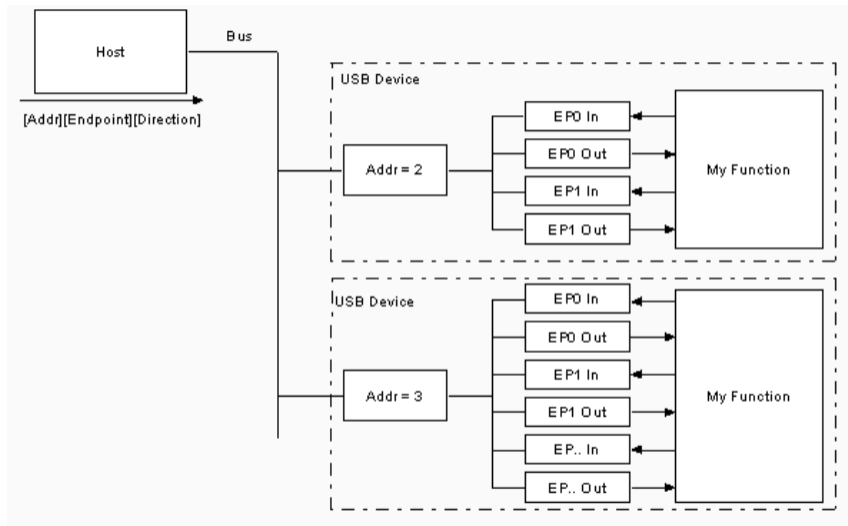

USB Keyboard: lusb (highlights)

Bus 002 Device 007: ID 413c:2003 Dell Computer Corp. Keyboard

Device Descriptor:

bDeviceClass 0 (Defined at Interface level)

idVendor 0x413c Dell Computer Corp.

idProduct 0x2003 Keyboard

bNumConfigurations 1

Configuration Descriptor:

bNumInterfaces 1

Interface Descriptor:

bInterfaceNumber 0

bNumEndpoints 1

bInterfaceClass 3 Human Interface Device

bInterfaceSubClass 1 Boot Interface Subclass

bInterfaceProtocol 1 Keyboard

iInterface 0

HID Device Descriptor:

bcdHID 1.10

bNumDescriptors 1

bDescriptorType 34 Report

wDescriptorLength 65

Endpoint Descriptor:

bEndpointAddress 0x81 EP 1 IN

bmAttributes 3

Transfer Type Interrupt

Synch Type None

Usage Type Data

wMaxPacketSize 0x0008 1x 8 bytes

Bus 001 Device 006: ID 0bda:0119 Realtek Semiconductor Corp. Storage Device (SD card reader)

Device Descriptor:

bDeviceClass 0 (Defined at Interface level)
idVendor 0x0bda Realtek Semiconductor Corp.
idProduct 0x0119 Storage Device (SD card reader)
bNumConfigurations 1

Configuration Descriptor:

bNumInterfaces 1
bConfigurationValue 1
iConfiguration 4 CARD READER
bmAttributes 0x80
(Bus Powered)
MaxPower 500mA

Interface Descriptor:

bNumEndpoints 2
bInterfaceClass 8 Mass Storage
bInterfaceSubClass 6 SCSI
bInterfaceProtocol 80 Bulk-Only

Endpoint Descriptor:

bEndpointAddress 0x01 EP 1 OUT
bmAttributes 2
Transfer Type Bulk
Synch Type None
Usage Type Data
wMaxPacketSize 0x0200 1x 512 bytes

Endpoint Descriptor:

bLength 7
bDescriptorType 5
bEndpointAddress 0x82 EP 2 IN
bmAttributes 2
Transfer Type Bulk
Synch Type None
Usage Type Data
wMaxPacketSize 0x0200 1x 512 bytes

libusb 1.0

Libusb 1.0

User-level C library for USB device access. lusb built on it.

`www.libusb.org`

1.0 API supplants earlier libusb 0.1

Nice tutorial: <http://www.dreamincode.net/forums/topic/148707-introduction-to-using-libusb-10/>

Using libusb

1. Initialize the library with *libusb_init()*
2. Select your device from the list returned by *libusb_get_device_list()*.
Later, free the list with *libusb_free_device_list()*.
3. Initiate contact with *libusb_open()*
4. Claim the interface with *libusb_claim_interface()*
5. Communicate using the various *libusb_..._transfer()* functions
6. Release the interface with *libusb_release_interface()*
7. Close the device with *libusb_close()*
8. Close the library with *libusb_exit()*

libusb: Finding a Keyboard

```
libusb_device **devs;
struct libusb_device_descriptor desc;
struct libusb_device_handle *keyboard = NULL;
ssize_t num_devs, d; uint8_t i, k;
uint8_t *endpoint_address;
num_devs = libusb_get_device_list(NULL, &devs);
for (d = 0 ; d < num_devs ; d++) {
    libusb_device *dev = devs[d];
    libusb_get_device_descriptor(dev, &desc);

    if (desc.bDeviceClass == LIBUSB_CLASS_PER_INTERFACE) {
        struct libusb_config_descriptor *config;
        libusb_get_config_descriptor(dev, 0, &config);
        for (i = 0 ; i < config->bNumInterfaces ; i++)
            for ( k = 0 ; k < config->interface[i].num_altsetting ; k++ ) {
                const struct libusb_interface_descriptor *inter =
                    config->interface[i].altsetting + k;
                if ( inter->bInterfaceClass == LIBUSB_CLASS_HID &&
                    inter->bInterfaceProtocol == USB_HID_KEYBOARD_PROTOCOL) {
                    libusb_open(dev, &keyboard);
                    *endpoint_address = inter->endpoint[0].bEndpointAddress;
                    libusb_claim_interface(keyboard, i);
                    libusb_free_device_list(devs, 1);
                    return keyboard;
                }
            }
    }
}
```

libusb: Reading from a Keyboard

```
#define USB_LCTRL (1 << 0)
#define USB_LSHIFT (1 << 1)
#define USB_LALT (1 << 2)
#define USB_LGUI (1 << 3)
#define USB_RCTRL (1 << 4)
#define USB_RSHIFT (1 << 5)
#define USB_RALT (1 << 6)
#define USB_RGUI (1 << 7)

struct usb_keyboard_packet {
    uint8_t modifiers;
    uint8_t reserved;
    uint8_t keycode[6];
};

struct libusb_device_handle *keyboard;
uint8_t endpoint_address;

libusb_interrupt_transfer(keyboard, endpoint_address,
                          (unsigned char *) &packet,
                          sizeof(packet),
                          &transferred, 0);

if (transferred == sizeof(packet))
    // Got a new keyboard event
```

USB HID Keyboard Protocol Packet

Page 60 of http://www.usb.org/developers/hidpage/HID1_11.pdf

Byte	Meaning
0	Modifier keys
1	Reserved
2	Keycode 1
	⋮
7	Keycode 6

USB HID Keycodes

Page 53: http://www.usb.org/developers/hidpage/Hut1_12v2.pdf

Code	Meaning
-------------	----------------

0	No event
---	----------

⋮

4	a or A
---	--------

5	b or B
---	--------

00 00 00 00 00...	00	Nothing pressed
-------------------	----	-----------------

00 00 04 00 00...	00	"A" pressed
-------------------	----	-------------

⋮

02 00 04 00 00...	00	Shift+A
-------------------	----	---------

29	z or Z
----	--------

03 00 04 00 00...	00	Shift+Ctrl+A
-------------------	----	--------------

30	1 or !
----	--------

02 00 04 00 00...	00	Shift+A
-------------------	----	---------

⋮

02 00 04 05 00...	00	Shift+A+B
-------------------	----	-----------

38	9 or (
----	--------

39	0 or)
----	--------

40	Enter
----	-------

⋮

POSIX Threads (pthreads)

Creation and Termination

```
#include <stdio.h>
#include <pthread.h>

void *mythread(void *ptr)
{
    printf("%s\n", (char *)ptr);
    return NULL;
}

int main()
{
    pthread_t thread1, thread2;
    const char *message1 = "Thread_1", *message2 = "Thread_2";

    pthread_create( &thread1, NULL, mythread, (void *)message1);
    pthread_create( &thread2, NULL, mythread, (void *)message2);

    pthread_join( thread1, NULL);
    pthread_join( thread2, NULL);

    return 0;
}
```

Mutexes: Ensuring atomic access

```
#include <stdio.h>
#include <pthread.h>

pthread_mutex_t mutex1 = PTHREAD_MUTEX_INITIALIZER;
int counter = 0; /* Caution: shared variable */

void *incCounter() {
    int tmp;
    pthread_mutex_lock(&mutex1); /* Grab the lock */
    tmp = counter; /* Needlessly complicated to make a point */
    tmp = tmp + 1;
    counter = tmp;
    pthread_mutex_unlock(&mutex1); /* Release the lock */
    return NULL;
}

int main() {
    pthread_t thread1, thread2;
    pthread_create( &thread1, NULL, &incCounter, NULL);
    pthread_create( &thread2, NULL, &incCounter, NULL);
    pthread_join( thread1, NULL);
    pthread_join( thread2, NULL);
    return 0;
}
```

Condition Variables: Notifying waiters

```
pthread_mutex_t mutex1 = PTHREAD_MUTEX_INITIALIZER;
pthread_cond_t cond1 = PTHREAD_COND_INITIALIZER;
int count; int valid = 0;
void *writeCounter() {
    int i;
    for (i = 0 ; i < 10 ; i++) {
        pthread_mutex_lock(&mutex1);
        while (valid) pthread_cond_wait(&cond1, &mutex1);
        count = i; valid = 1;
        pthread_cond_signal(&cond1);
        pthread_mutex_unlock(&mutex1);
    }
    return NULL; }
void *readCounter() {
    int done = 0;
    do {
        pthread_mutex_lock(&mutex1);
        while (!valid) pthread_cond_wait(&cond1, &mutex1);
        printf("%d\n", count);
        valid = 0; done = count == 9;
        pthread_cond_signal(&cond1);
        pthread_mutex_unlock(&mutex1);
    } while (!done);
    return NULL; }
```