

Video

CSEE W4840

Prof. Stephen A. Edwards

Columbia University

Spring 2024

Television: 1939 Du Mont Model 181

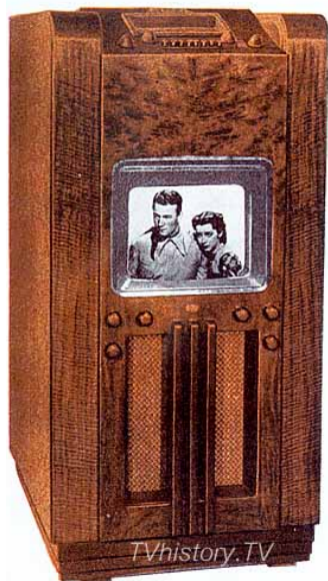

The Model 181 is a high console model which provides television sight and sound entertainment with a selection of four (4) television channels. The black and white picture of pleasing contrast is reproduced on the screen of the 14 inch teletron, and measures 8 inches by 10 inches. The beautifully grained walnut cabinet of pleasing modern design measures 48 $\frac{5}{8}$ inches high, 23 inches wide and 26 inches deep. It is completely A.C., operated from standard 110 volt 60 cycle power lines. Twenty-two (22) tubes including the Du Mont Teletron are employed in the superhetrodyne circuit. A dynamic speaker is used for perfect sound reproduction. In addition, a three-band superhetrodyne all wave radio is provided for standard radio reception. This receiver employs 8 tubes, is completely A.C. operated from 110 volt 60 cycle power lines. Push button and manual tuning are provided. An individual dynamic speaker is used for broadcast sound reproduction.

*Model
181*

Inside a CRT

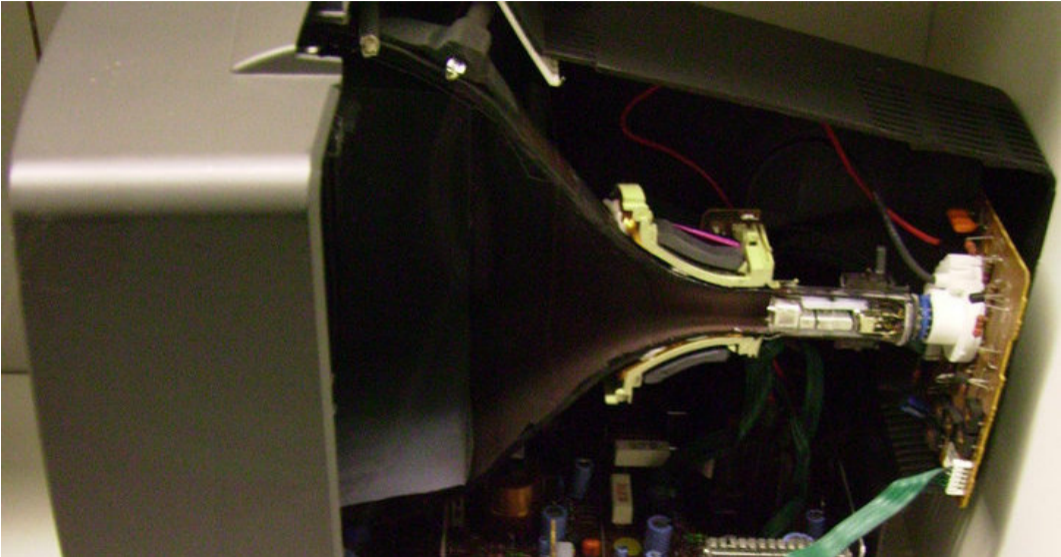

London Science Museum/renaissancechambara

Inside a CRT

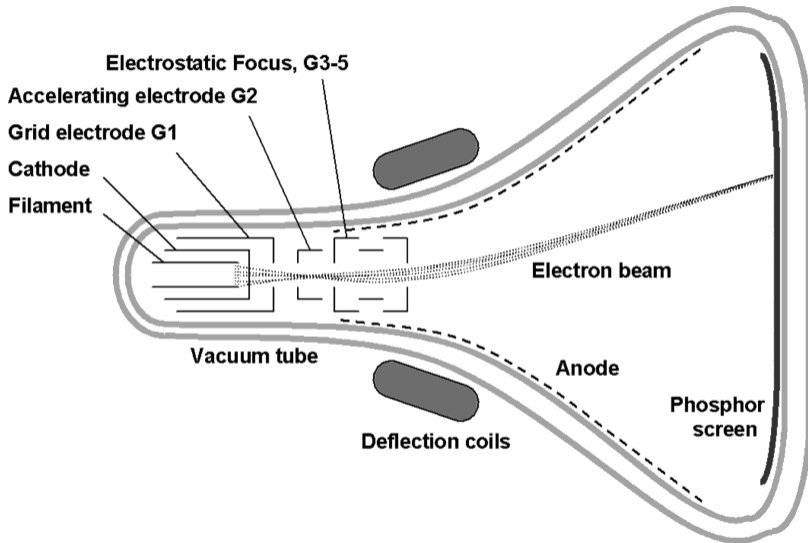

Vector Displays



Raster Scanning



Raster Scanning

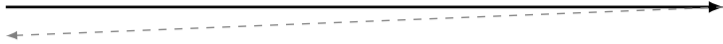

Raster Scanning

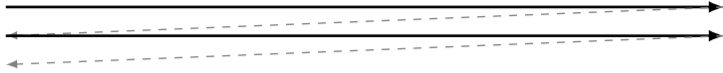

Raster Scanning

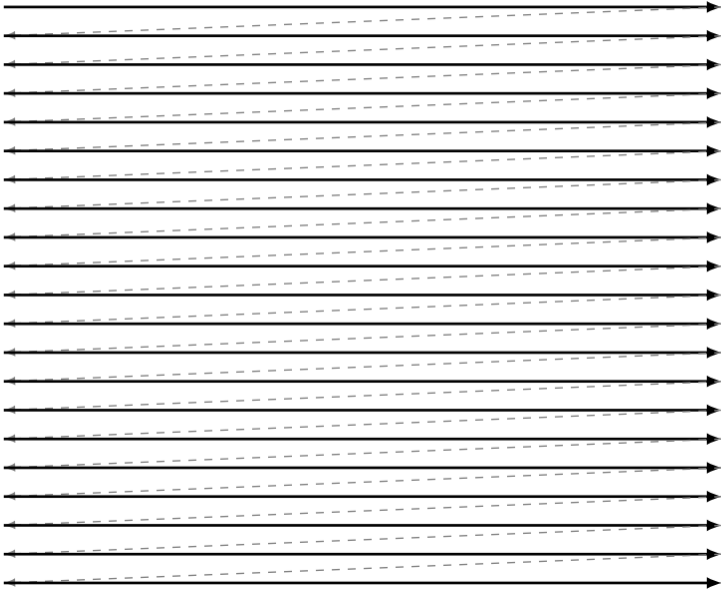

Raster Scanning

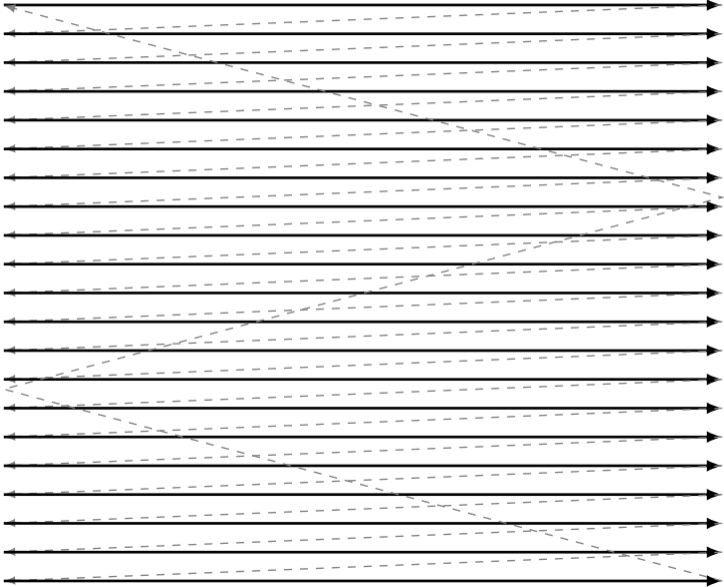

NTSC or RS-170

Originally black-and-white

60 Hz vertical scan frequency

15.75 kHz horizontal frequency

$$\frac{15.75 \text{ kHz}}{60 \text{ Hz}} = 262.5 \text{ lines per field}$$

White	1 V
Black	0.075 V
Blank	0 V
Sync	- 0.4 V

A Line of B&W Video

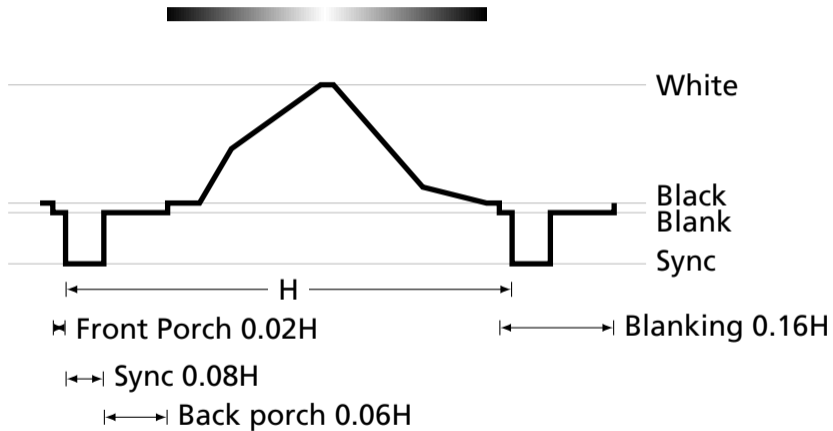

LCDs Also Use Raster Scanning

32F50 320 × 240 Monochrome LCD Module

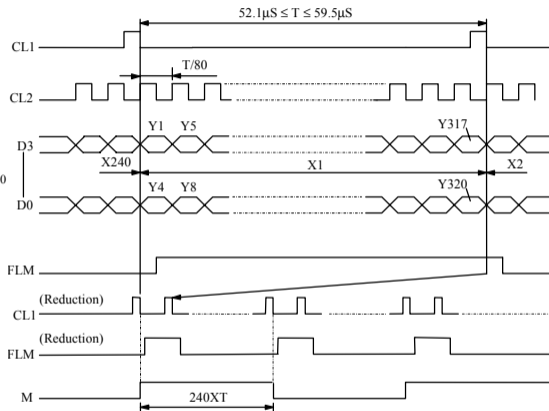
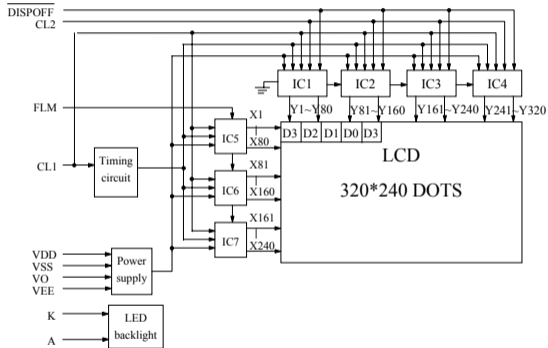

4-bit parallel interface

CL2: word clock

CL1: "horizontal sync"

FLM: "vertical sync"

Interlaced Scanning



Interlaced Scanning



Interlaced Scanning

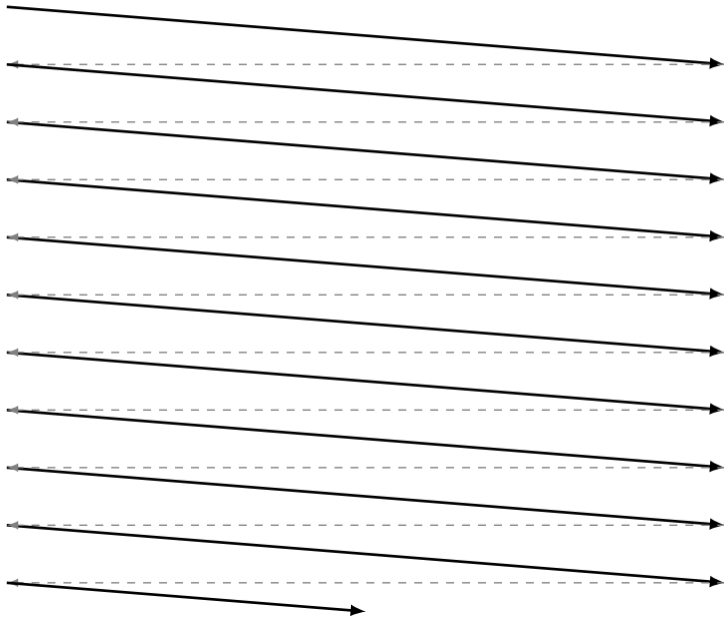

Interlaced Scanning

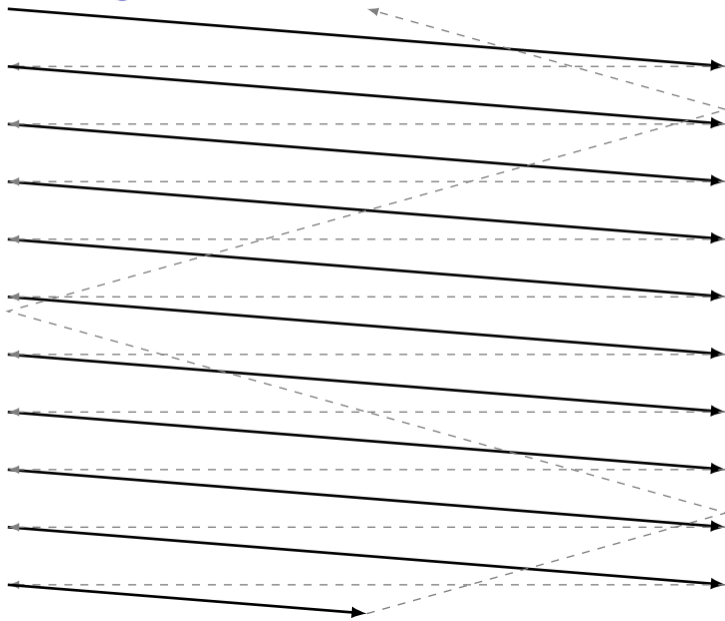

Interlaced Scanning

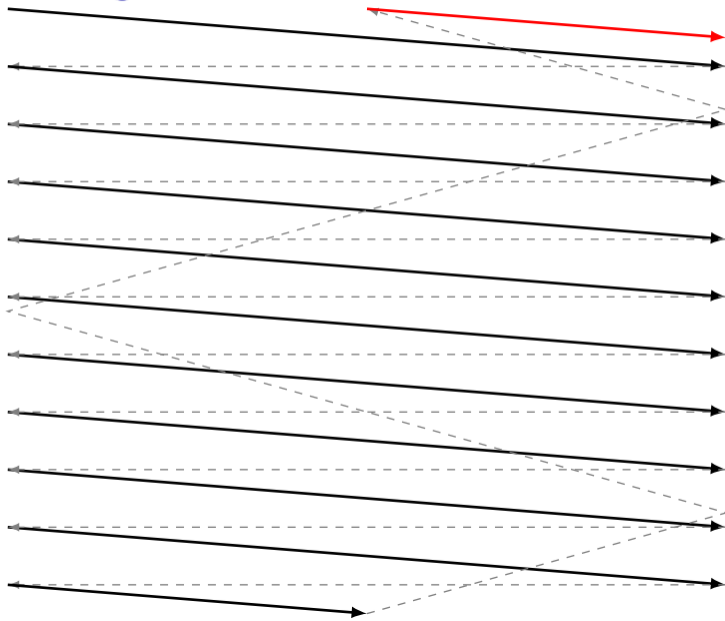

Interlaced Scanning

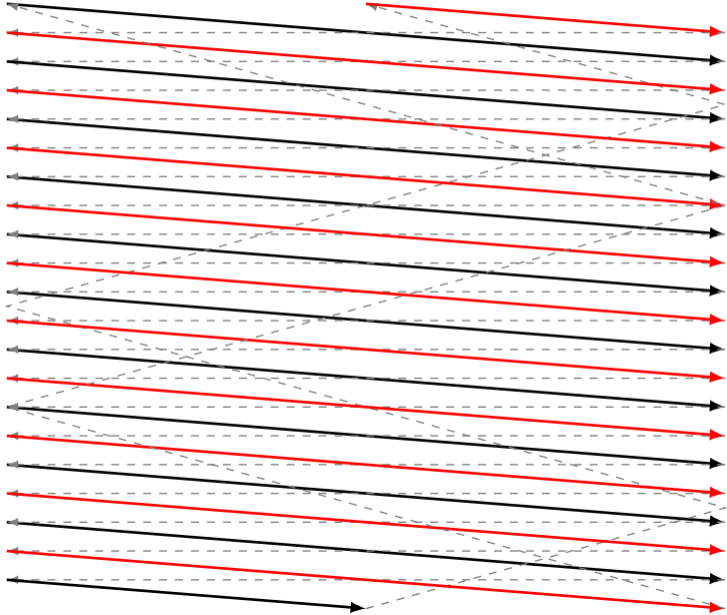

Color Television

Color added later: had to be backwards compatible.

Solution: continue to transmit a “black-and-white” signal and modulate two color “difference” signals on top of it

RGB vs. YIQ colorspaces

$$\begin{bmatrix} 0.30 & 0.59 & 0.11 \\ 0.60 & -0.28 & -0.32 \\ 0.21 & -0.52 & 0.31 \end{bmatrix} \begin{bmatrix} R \\ G \\ B \end{bmatrix} = \begin{bmatrix} Y \\ I \\ Q \end{bmatrix}$$

Y baseband 4 MHz “black-and-white” signal

I as 1.5 MHz, Q as 0.5 MHz at 90°: modulated at 3.58 MHz

CIE Color Matching Curves

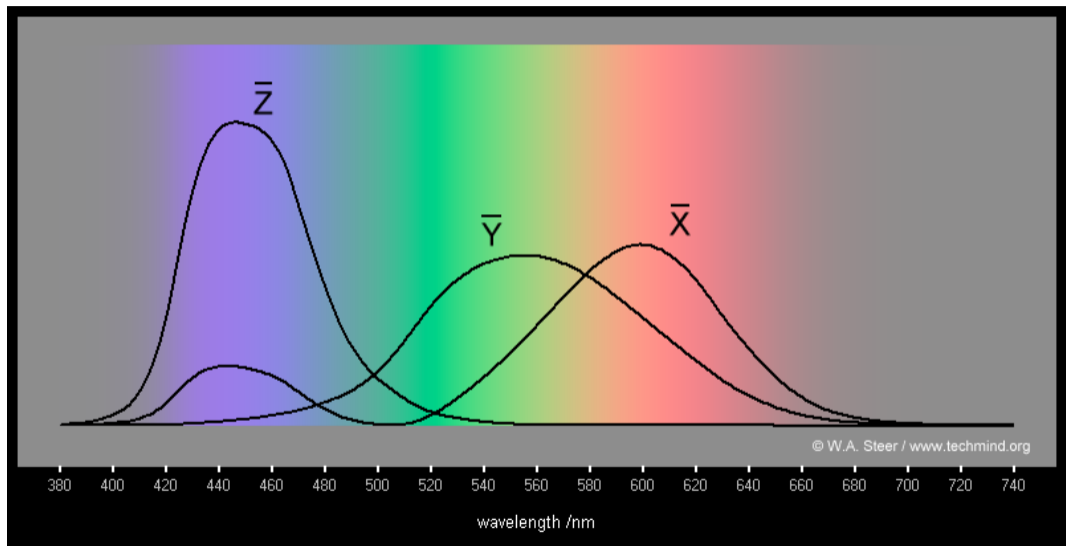

YIQ color space with $Y=0.5$

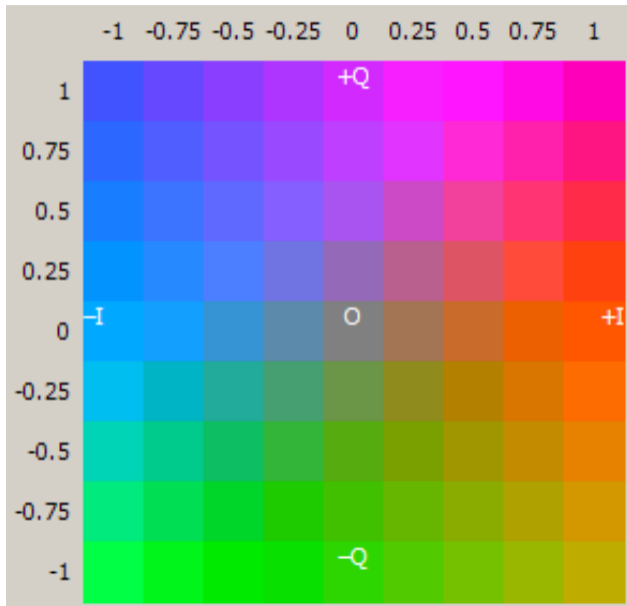

International Standards

	lines	active lines	vertical res.	aspect ratio	horiz. res.	frame rate
NTSC	525	484	242	4:3	427	29.94 Hz
PAL	625	575	290	4:3	425	25 Hz
SECAM	625	575	290	4:3	465	25 Hz

PAL: Uses YUV instead of YIQ, flips phase of V every other line

SECAM: Transmits the two chrominance signals on alternate lines; no quadrature modulation

Computer Video: VGA

1 Red	2 Green	3 Blue	4 ID2	5 GND
6 RGND	7 GGND	8 BGND	9 (+5V)	10 GND
11 ID0	12 ID1	13 hsync	14 vsync	15 ID3

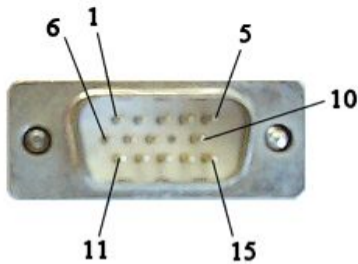

ID2	ID0	ID1	
-	-	GND	Monochrome, $< 1024 \times 768$
-	GND	-	Color, $< 1024 \times 768$
GND	GND	-	Color, $\geq 1024 \times 768$

DDC1 ID2 Data from display
vsync also data clock

DDC2 ID1 I²C SDA
ID3 I²C SLC

VGA Timing

Mode	Resolution	Vertical	Horizontal	Pixel Clock
VGA	640×350	70 Hz	31.5 kHz	25.175 MHz
VGA	640×400	70 Hz	31.5 kHz	25.175 MHz
VGA	640×480	59.94 Hz	31.469 kHz	25.175 MHz
SVGA	800×600	56 Hz	35.2 kHz	36 MHz
SVGA	800×600	60 Hz	37.8 kHz	40 MHz
SVGA	800×600	72 Hz	48.0 kHz	50 MHz
XGA	1024×768	60 Hz	48.5 kHz	65 MHz
SXGA	1280×1024	61 Hz	64.2 kHz	110 MHz
HDTV	1920×1080i	60 Hz		
UXGA	1600×1200	60 Hz	75 kHz	162 MHz
UXGA	1600×1200	85 Hz	105.77 kHz	220 MHz
WUXGA	1920×1200	70 Hz	87.5 kHz	230 MHz

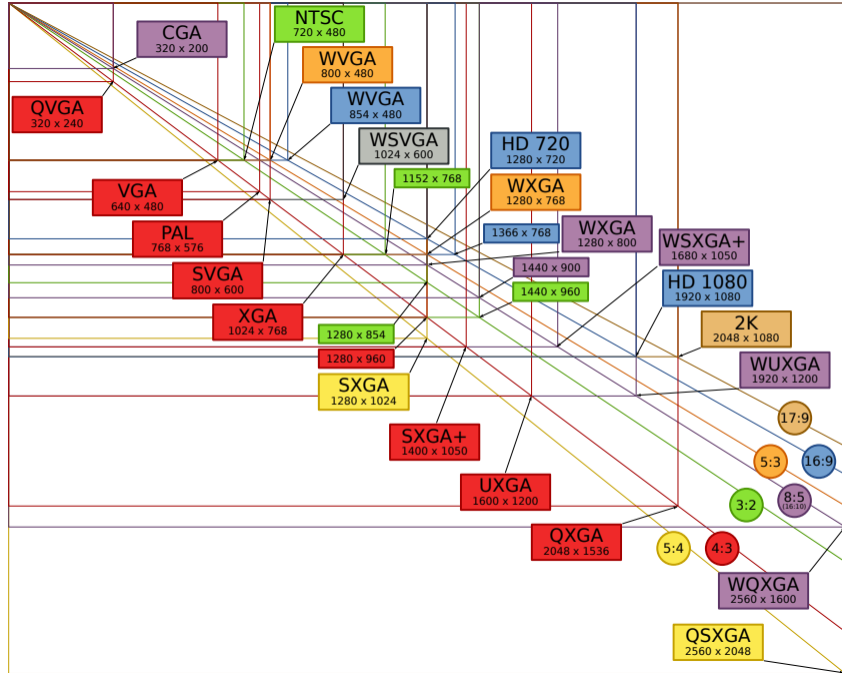

Detailed VGA Timing

640 × 480, "60 Hz"

25.175 MHz Dot Clock
31.469 kHz Line Frequency
59.94 Hz Field Frequency

Pixels	Role
8	Front Porch
96	Horizontal Sync
40	Back Porch
8	Left border
640	Active
8	Right border
800	total per line

Lines	Role
2	Front Porch
2	Vertical Sync
25	Back Porch
8	Top Border
480	Active
8	Bottom Border
525	total per field

Active-low Horizontal and Vertical sync signals.

Horizontal Timing

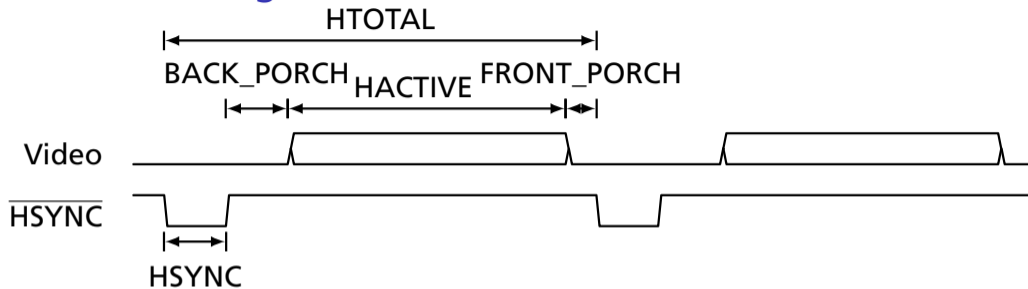

For a 25.175 MHz pixel clock,

HSYNC	96 pixels
BACK_PORCH	48
HACTIVE	640
FRONT_PORCH	16
<hr/>	
HTOTAL	800